

# SURGICAL INSTRUMENTS



**SAAMS**  
INSTRUMENTS  
[www.saamsinst.com](http://www.saamsinst.com)



**SI-1-101-18**

**Buck**

Percussion Hammer  
18.5 cm,



**SI-1-102-18**

**Buck**

Percussion Hammer  
20cm,



**SI-1-103-20**

**Dejerine**

Percussion Hammer  
20cm,



**SI-1-104-21**

**Dejerine**

Percussion Hammer  
21cm,



**SI-1-105-20**

**Taylor Mod. USA**

Percussion Hammer  
20cm,



**SI-1-106-19**

**Wartenberg**

Pinwheel  
18cm,



**SI-1-107-18**

**Pinard**

Stethoscope  
18 cm,



**SI-1-108-15**

**Pinard**

Stethoscope  
15cm,



**SI-2-101-15**

**Magill**

Catheter Introducing Forceps  
14.5 cm, 20 cm, 25 cm,



**SI-2-102-00**

**Miller**

Laryngoscope Sets



**SI-2-103-00**

**Millar-Baby**

Laryngoscope Sets



**SI-2-104-00**

**Miller**

Laryngoscope Blade  
Fig. 0, Fig. 1, Fig. 2, Fig. 3, Fig. 4,



**SI-2-105-00**

**Guedel-Negus**

Laryngoscope Sets  
Fig. 2, Fig. 3, Fig. 4,



**SI-2-106-00**

**Guedel-Negus**

Laryngoscope Sets  
Fig. 1, Fig. 2, Fig. 3, Fig. 4,





**SI-2-107-01**

**Guedel-Negus**

Laryngoscope Blades  
Fig. 1, Fig. 2, Fig. 3, Fig. 4,



**SI-2-108-00**

**McIntosh**



**SI-2-109-00**

**McIntosh**

Laryngoscope Blades  
Fig. 0, Fig. 1, Fig. 2, Fig. 3, Fig. 4,



**SI-2-110-00**

**McIntosh**

Laryngoscope Sets  
Fig. 1, Fig. 2, Fig. 3, Fig. 4,



**SI-2-111-01**

**Foregger**

Laryngoscope Blades  
Fig. 1, Fig. 2, Fig. 3, Fig. 4,



**SI-2-112-00**

**Battery Handle**

Battery Handle



**SI-3-101-04**

**Universal**

Trocar  
14 cm,



**SI-3-102-07**

**Nelson**

Trocar  
20 cm,



**SI-3-103-19**

**Lichtwitz**

Antrum Trocar  
18.5 cm,



**SI-3-104-21**

**Adson**

Suction Cannula  
20 cm,



**SI-3-105-10**

**Frazier**

Suction Cannula  
24 cm,



**SI-3-106-06**

**Frazier**

Suction Cannula  
19.5 cm,



**SI-3-107-06**

**Poppen**

Suction Cannula  
18 cm,



**SI-3-108-30**

**Luer**

Suction Tube working length 110 mm



**SI-3-109-15**

**Yasargil**

Suction Tube working length 150 mm with  
Luer hub  
21.5 cm,



**SI-3-110-27**

**Yankauer**

Suction Tube complete with suction tip  
and connector  
31 cm,



**SI-3-111-00**

**Yankauer**

Suction Tube  
31 cm, 15 cm, 2.5 cm, 10 cm,



**SI-3-112-22**

**Poole**

Suction Tube  
22 cm,



**SI-3-113-22**

**Poole**

Suction Tube  
22.5 cm,



**SI-3-114-21**

**Nuboer**

Suction Tube  
21 cm,



**SI-3-115-21**

**Nuboer**

Suction Tube  
21 cm,



**SI-3-116-10**

**Quinke**

Lumbar Puncture Needle



**SI-3-117-12**

**Tuohy**

Lumbar Puncture Needle Luer Lock  
connection with special tip



**SI-3-118-20**

**Verres**

Insufflation Cannula Luer Lock  
connection  
15 cm,



**SI-3-119-20**

**Verres**

Insufflation Cannula Luer Lock  
connection

17 cm,



**SI-4-105-14**

**Kalt**

Needle Holder  
13.5 cm,



**SI-4-106-10**

**Barraquer-Troutman**

Micro Needle Holder  
10 cm, 10.5 cm,



**SI-4-107-14**

**Arruga**

Micro Needle Holder  
13.5 cm,



**SI-4-108-10**

**Barraquer-Troutman**

Micro Needle Holder  
10.5 cm, 11.5 cm,



**SI-4-109-11**

**Barraquer**

Micro Needle Holder  
11.5 cm, 13.5 cm, 14 cm,



**SI-4-110-13**

**Barraquer**

Micro Needle Holder  
13.5 cm,





**SI-4-111-01**

**Castroviejo-Fino**

Micro Needle Holder  
13 cm,



**SI-4-112-01**

**Castroviejo-Fino**

Micro Needle Holder  
13 cm,



**SI-4-113-01**

**Castroviejo-Fino**

very delicate jaw with lock  
13 cm,



**SI-4-114-14**

**Castroviejo**

Micro Needle Holder with lock  
14 cm,



**SI-4-115-14**

**Castroviejo**

Micro Needle Holder  
14 cm,



**SI-4-121-14**

**Castroviejo**

Micro Needle Holder with lock  
14 cm,



**SI-4-122-14**  
**Castroviejo**

Micro Needle Holder  
14 cm,



**SI-4-124-13**  
**Castroviejo**

Micro Needle Holder with lock  
12 cm,



**SI-4-123-16**  
**Arruga**

Needle Holder delicate  
16 cm,



**SI-4-125-12**  
**Castroviejo**

Micro Needle Holder with lock  
12 cm,



**SI-4-126-12**  
**Derf**

Needle Holder  
12 cm, 13 cm,



**SI-4-127-12**  
**Collier**

Needle Holder  
12.5 cm,



**SI-4-128-13**

**Webster**

Needle Holder  
13 cm,



**SI-4-129-13**

**Halsey**

Needle Holder  
13.5 cm,



**SI-4-130-13**

**Neivert**

Needle Holder  
12.5 cm,



**SI-4-131-14**

**Hegar-Baumgartner**

Needle Holder  
14.5 cm,



**SI-4-133-15**

**Crile-Murray**

Needle Holder  
15 cm,



**SI-4-134-15**

**Crile-Wood**

Needle Holder  
15 cm,



**SI-4-140-18**

**Adson**

Needle Holder one fenestrated jaw  
18 cm,



**SI-4-141-18**

**Metzenbaum**

Needle Holder one grooved and  
fenestrated jaw  
18.5 cm,



**SI-4-142-17**

**M. G. Hospital**

Needle Holder  
17.5 cm,



**SI-4-143-14**

**Mayo-Hegar**

Needle Holder  
14.5 cm, 16 cm, 18.5 cm, 20.5 cm, 24  
cm, 26.5 cm,



**SI-4-144-16**

**Mayo-Hegar**

Needle Holder  
16 cm, 18.5 cm, 20.5 cm,



**SI-4-145-13**

**Brown**

Needle Holder  
13 cm, 18 cm,

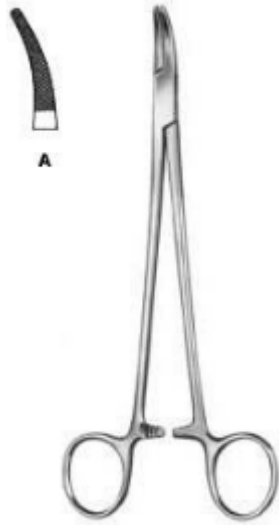

**SI-4-146-21**

**Heaney**

Needle Holder  
20.5 cm,



**SI-4-147-23**

**Jamison**

Needle Holder  
23.5 cm,



**SI-4-148-27**

**Masson**

Needle Holder  
26.5 cm,



**SI-4-149-27**

**Finochietto**

Needle Holder  
26.5 cm,



**SI-4-150-27**

**Wangensteen**

Needle Holder  
26.5 cm,

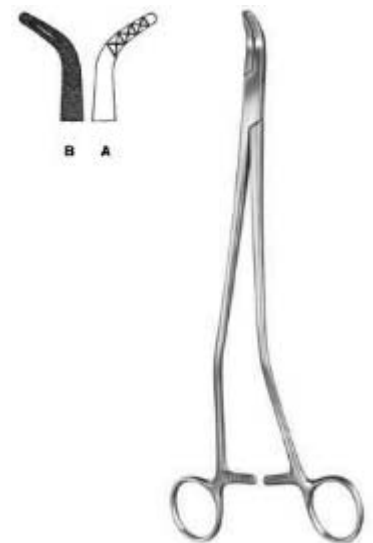

**SI-4-151-27**

**Johnson**

Needle Holder  
27 cm,

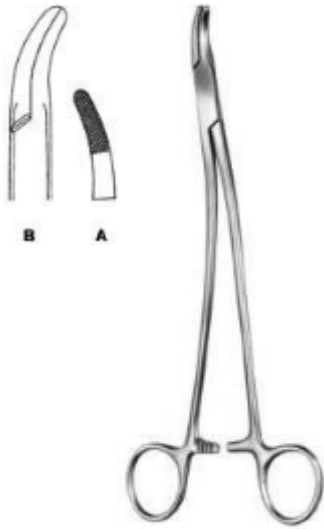

**SI-4-152-23**

**Stratte**

Needle Holder  
23 cm,

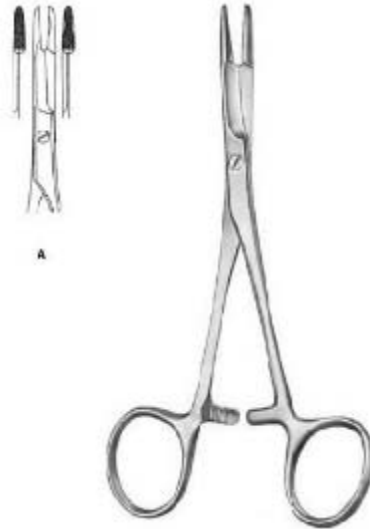

**SI-4-153-14**

**Olsen-Hegar**

Needle Holder  
14 cm,

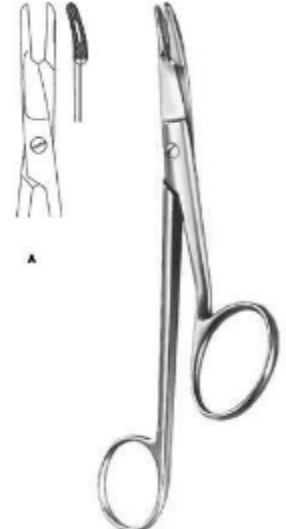

**SI-4-154-16**

**Gillies**

Needle Holder  
16 cm,



**SI-4-155-15**

**Crile**

Needle Holder  
15 cm,



**SI-4-156-14**

**Mathieu**

Needle Holder  
14 cm, 17 cm, 20 cm,



**SI-4-157-14**

**Mathieu**

Needle Holder  
14 cm, 16.5 cm,





**SI-4-158-18**

**Toennis**

Needle Holder  
18.5 cm,



**SI-4-159-20**

**Lichtenberg**

Needle Holder  
20 cm,



**SI-4-160-16**

Micro Needle Holder  
16 cm,



**SI-4-161**

Micro Needle Holder  
23 cm, 19 cm,



**SI-4-162-18**

**Hepp-Scheidel**

Micro Needle Holder smooth jaw  
18 cm,



**SI-4-163-13**

**Webster**

Needle Holder with automatic release  
ratchet also for lefthanders  
13 cm, 15 cm,



**SI-4-164-15**

Micro Needle Holder  
15 cm, 18 cm, 21 cm, 23 cm,



**SI-4-165-18**

**JABOMA**  
Micro Needle Holder  
18 cm,



**SI-4-166**

**Castroviejo**  
Micro Needle Holder  
14.5 cm, 18 cm, 21.5 cm,



**SI-4-167**

**Arruga**  
Needle Holder  
16 cm,



**SI-4-168-13**

**Castroviejo**  
Micro Needle Holder  
12.5 cm,



**SI-4-169-13**

**Barraquer**  
Micro Needle Holder  
13 cm,



**SI-4-170-13**

**Barraquer**

Micro Needle Holder  
13 cm,



**SI-4-171-13**

**Webster**

Needle Holder  
13 cm,



**SI-4-173-12**

**Derf**

Needle Holder  
12 cm,

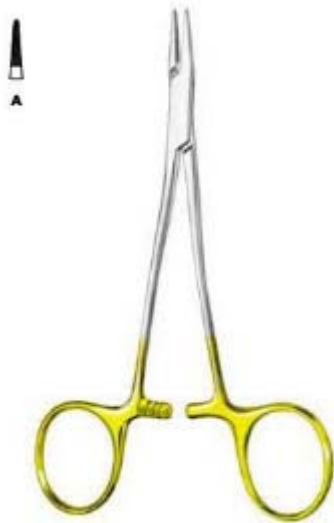

**SI-4-172-13**

**Kilner**

Needle Holder  
13 cm,



**SI-4-174-13**

**Hegar-Baumgartner**

Needle Holder  
13 cm, 14.5 cm,



**SI-4-175-12**

**Halsey**

Needle Holder  
13 cm, 12 cm,



**SI-4-176-15**

**Crile-Wood**

Needle Holder  
15 cm,



**SI-4-177-18**

**Sarot**

Needle Holder  
18 cm, 20 cm, 26 cm,

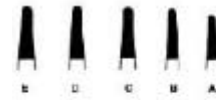

**SI-4-178-16**

**Mayo-Hegar**

Needle Holder standard profile  
16 cm, 18 cm, 20 cm, 24 cm, 26 cm, 30 cm,



**SI-4-179-20**

**Heaney**

Needle Holder  
20 cm, 24 cm, 26 cm,



**SI-4-180-18**

**DeBakey**

Needle Holder delicate pattern mini  
profile  
18 cm, 20 cm, 23 cm, 26 cm, 31 cm,



**SI-4-181-27**

**Masson**

Needle Holder  
26.5 cm,



**SI-4-182-13**

**Ryder (Martin)**

Needle Holder

12.5 cm, 15 cm, 18 cm, 20 cm, 23 cm, 26 cm,



**SI-4-183-15**

**Martin**

Needle Holder mini profile elastic type

15 cm, 17 cm, 20 cm,



**SI-4-184-27**

**Wangensteen**

Needle Holder standard profile

27 cm,



**SI-4-185-14**

**Hegar-Vascular**

Needle Holder micro profile

14 cm, 18.5 cm, 20.5 cm, 23 cm,

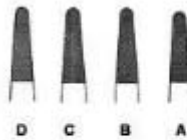

**SI-4-186-20**

**Bozemann**

Needle Holder standard profile

20.5 cm, 24 cm, 26.5 cm, 29 cm,



**SI-4-187-20**

**Hegar**

Needle Holder standard profile

20 cm, 23.5 cm,



**SI-4-188-22**

**Stratte**

Needle Holder standard profile  
23 cm,



**SI-4-189-00**

**Microvascular**

Needle Holder slender pattern micro  
profile  
14 cm, 17.5 cm, 20 cm, 23 cm,



**SI-4-190-14**

**Mathieu**

Needle Holder  
14 cm, 17 cm, 20 cm,



**SI-4-191-14**

**Mathieu**

Needle Holder  
14 cm, 17 cm, 20 cm,



**SI-4-192-17**

**Mathieu**

Needle Holder standard profile with  
interior ratchet  
17 cm, 20 cm, 23 cm,



**SI-4-193-18**

**Toennis**

Needle Holder  
18.5 cm,





**SI-4-194-20**

**Lichtenberg**

Needle Holder lightweight model  
standard profile  
20 cm,



**SI-4-195-18**

**Langenbeck**

Needle Holder  
18 cm, 20.5 cm, 23 cm,



**SI-4-196-20**

**Zweifel**

Needle Holder with hinged ratchet  
standard profile  
20.5 cm, 23 cm,



**SI-4-197-15**

**Reverdin**

Reverdin Needle short  
14.5 cm Fig. 1, 14.5 cm Fig. 2, 14.5 cm  
Fig. 3, 14.5 cm Fig. 4,



**SI-4-198-19**

**Reverdin**

Reverdin Needle medium  
19.5 cm Fig. 1, 19.5 cm Fig. 2, 19.5 cm  
Fig. 3, 19.5 cm Fig. 4,



**SI-4-199-23**

**Reverdin**

Reverdin Needle long  
23 cm Fig. 1, 23 cm Fig. 2, 23 cm Fig. 3, 23  
cm Fig. 4,



**SI-4-201-01**

**Schmieden-Dick**

Ligature Needle malleable  
29 cm,

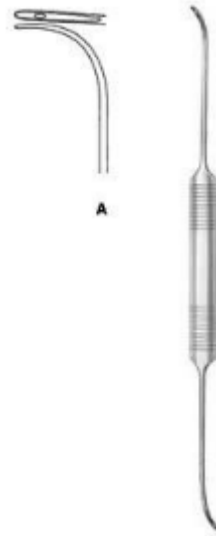

**SI-4-202-21**

**Schmieden**

Ligature Needle  
24 cm,



**SI-4-203-20**

Ligature Needle malleable  
20.5 cm,

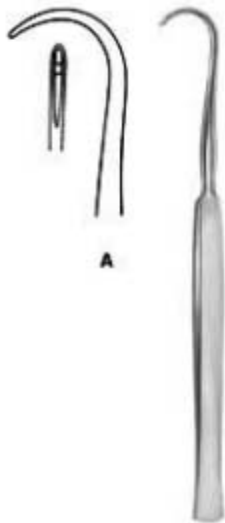

**SI-4-204-19**

**Cooper**

Ligature Needle  
18.5 cm,



**SI-4-205-13**

**Kronecker**

Ligature Needle delicate for right hand  
12.5 cm,



**SI-4-206-24**

**Deschamps**

Ligature Needle blunt for right hand  
24 cm,



**SI-4-207-20**

**Deschamps**

Ligature Needle blunt for right hand  
20 cm,



**SI-4-208-20**

**Deschamps**

Ligature Needle sharp for right hand  
20 cm,

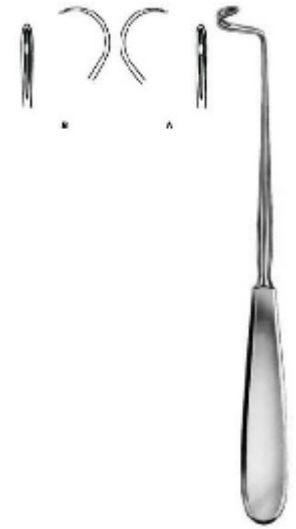

**SI-4-209-21**

**Deschamps**

Ligature Needle blunt for right hand  
20 cm,

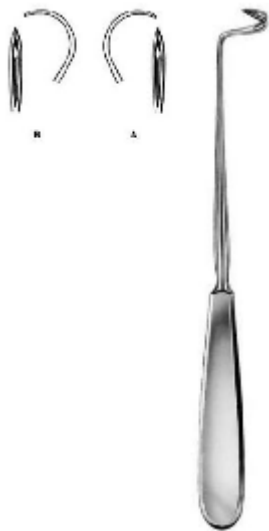

**SI-4-210-21**

**Deschamps**

Ligature Needle sharp for right hand  
20 cm,

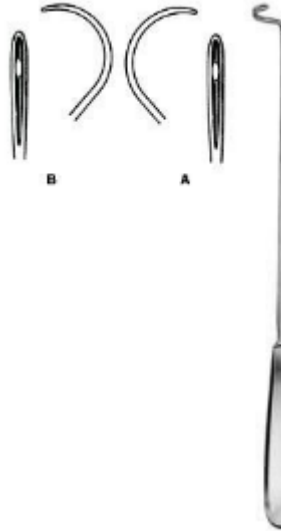

**SI-4-211-27**

**Deschamps**

Ligature Needle blunt for right hand  
27 cm,

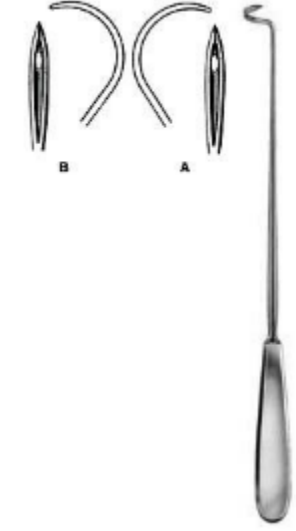

**SI-4-212-27**

**Deschamps**

Ligature Needle sharp for right hand  
27 cm,

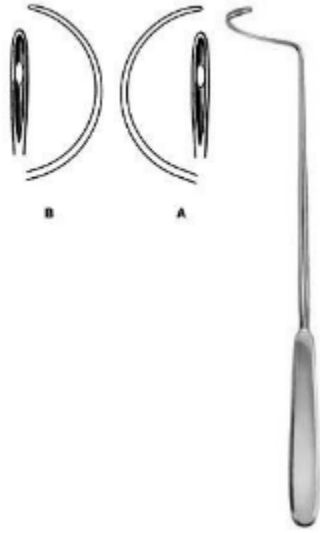

**SI-4-213-28**

**Deschamps**

Ligature Needle blunt for right hand  
28 cm,



**SI-4-214-20**

**Deschamps**

Ligature Needle sharp for right hand  
20 cm,



**SI-4-215-20**

**Deschamps**

Ligature Needle blunt for right hand  
20 cm,



**SI-4-216-20**

**Deschamps**

Ligature Needle blunt for right hand  
21 cm,

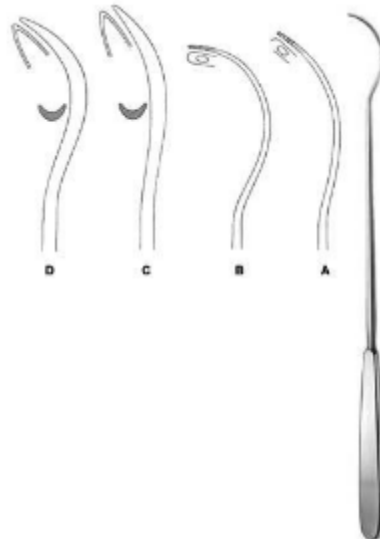

**SI-4-217-30**

**Brunner**

Ligature Needle  
21 cm,



**SI-4-218-25**

**Kirschner**

Ligature Conductor  
25.5 cm,



**SI-4-219-28**

Ligature Conductor  
28 cm,



**SI-4-220-23**

**Modell Wien**  
Ligature Catcher  
23.5 cm,



**SI-4-221-12**

**Michel**  
Clip Applying Forceps  
12 cm,



**SI-4-222-12**

**Hegenbarth**  
Clip Applying Forceps  
12 cm,



**SI-5-101-01**

Dissecting Knife with metal handle  
15 cm, 15.5 cm, 16 cm, 17 cm,



**SI-5-102-10**

Autopsy Knife  
25.5 cm,



**SI-5-104-17**

**Walb**  
Post Mortem Knife



**SI-5-105-20**

**Virchow**

Brain Knife with hollow handle  
28.5 cm, 33.5 cm, 38 cm,



**SI-5-108-04**

Scalpel Handle solid  
13.5 cm,



**SI-5-109-34**

Scalpel Handle  
16 cm,



**SI-5-110-41**

Scalpel Handle solid, long  
21 cm,



**SI-5-111-45**

Scalpel Handle  
21 cm,



**SI-5-112-08**

**Collin**  
Scalpel Handle with hollow handle  
13.5 cm,



**SI-5-113-09**

**Collin**  
Scalpel Handle with hollow handle  
14.5 cm,



**SI-5-114-03**

Scalpel Handle solid  
12 cm,



**SI-5-115-04**

Scalpel Handle  
12 cm,



**SI-5-116-05**

Scalpel Handle  
12 cm,



**SI-5-117-31**

Scalpel Handle solid, long  
21.5 cm,



**SI-5-118-35**

Scalpel Handle  
21 cm,



**SI-5-119-07**

Scalpel Handle solid  
16 cm,



**SI-5-120-71**

Scalpel Handle solid short  
12.5 cm,



**SI-5-121-03**

Scalpel Handle with round hollow handle  
15.5 cm,





**SI-5-127-16**

Amputation Knife with hollow handle  
29 cm,



**SI-5-128-19**

Amputation Knife with hollow handle  
32.5 cm,



**SI-5-129-16**

**Catlin**  
Interosseous Knife with hollow handle  
29cm,



**SI-5-130-06**

Resection Knife solid handle, dissecting  
end  
18 cm,



**SI-5-131-05**

**Langenbeck**  
Resection Knife  
18 cm,



**SI-5-132-05**

**Langenbeck**  
Resection Knife  
18 cm,



**SI-5-133-00**

Razor Knife hollow blades on both sides  
cutting length 75mm



**SI-5-134-00**

**Schink**

Dermatome complete with 2 skin fixing  
plates and one blade  
31 cm,



**SI-5-135-01**

**Schink**

Spare Blade spare blade for  
KE-05-134-00



**SI-5-136-02**

**Schink**

Skin Fixing Plate for KE-05-134-00



**SI-5-201-13**

**Standard BL / BL Straight**

Operating Scissors

12 cm, 13 cm, 14.5 cm, 16.5 cm, 18.5 cm, 20.5 cm,



**SI-5-202-13**

**Standard SH / BL STR**

Operating Scissors

12 cm, 13 cm, 14.5 cm, 16.5 cm, 18.5 cm, 20.5 cm,



**SI-5-204-13**

**Standard SH / SH STR**

Operating Scissors

12 cm, 13 cm, 14.5 cm, 16.5 cm,



**SI-5-205-13**

**Standard BL / BL Curved**

Operating Scissors

12 cm, 13 cm, 14.5 cm, 16.5 cm, 18.5 cm, 20.5 cm,



**SI-5-206-13**

**Standard SH / BL Curved**

Operating Scissors

12 cm, 13 cm, 14.5 cm, 16.5 cm, 18.5 cm, 20.5 cm,



**SI-5-207-13**

**Standard SH / SH Curved**

Operating Scissors

12 cm, 13 cm, 14.5 cm, 16.5 cm,



**SI-5-208-14**

**Standard BL / BL Curved**

Operating Scissors delicate  
14.5 cm,



**SI-5-209-14**

**Incision Scissor**

Operating Scissor  
14.5 cm,



**SI-5-210-14**

**Deaver**

Operating Scissors



**SI-5-211-15**

**Mayo**

Dissecting Scissors  
14.5 cm, 15 cm, 17 cm, 23.5 cm, 14.5 cm, 15 cm, 17 cm, 23.5 cm,



**SI-5-212-23**

**Mayo**

Dissecting Scissors  
23 cm, 22.5 cm, 28 cm,



**SI-5-213-22**

**Mayo-Harrington**

Dissecting Scissors  
23 cm, 22.5 cm, 28 cm,

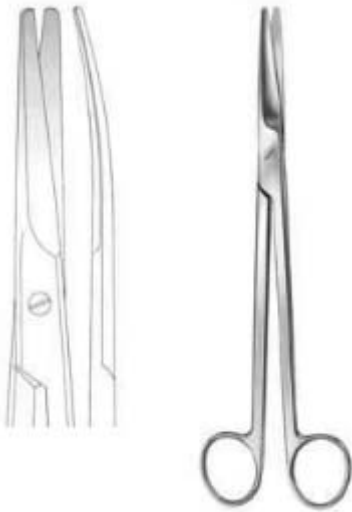

**SI-5-214-22**

**Mayo-Harrington**

Dissecting Scissors cur.  
22.5 cm, 28 cm, 23 cm,

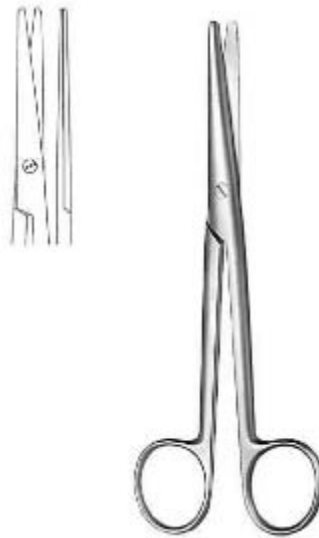

**SI-5-215-17**

**Mayo-Stille**

Dissecting Scissors str.  
15 cm, 17 cm,

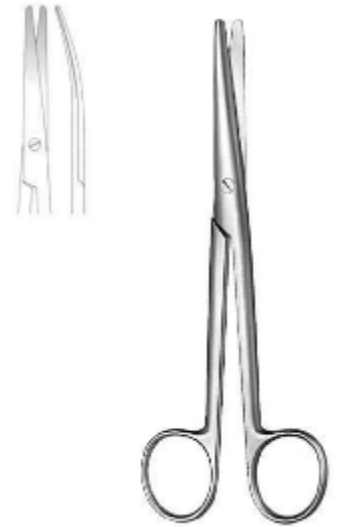

**SI-5-216-15**

**Mayo-Stille**

Dissecting Scissors cur.  
15 cm, 17 cm,

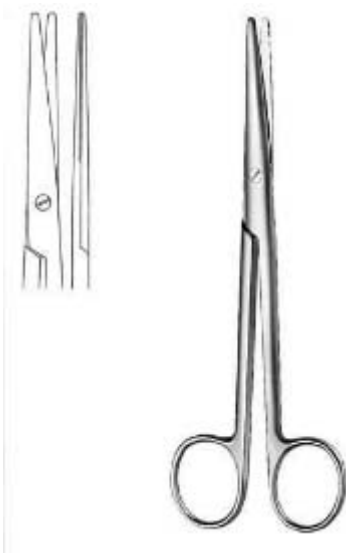

**SI-5-217-19**

**Mayo-Stille**

Dissecting Scissors str.  
16 cm, 19.5 cm, 21.5 cm,

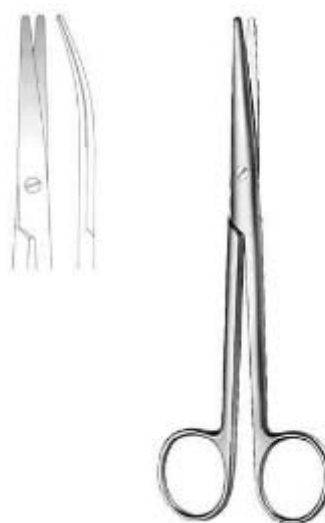

**SI-5-218-16**

**Mayo-Stille**

Dissecting Scissors cur.  
16 cm, 19.5 cm, 21.5 cm,



**SI-5-219-17**

**Mayo-Noble**

Gynecological Scissors  
16.5 cm,



**SI-5-220-23**

**Sims**

Gynecological Scissors str.  
20 cm, 23 cm,



**SI-5-221-20**

**Sims**

Gynecological Scissors cur.  
20 cm, 23 cm,



**SI-5-222-16**

**Kelly**

Operating Scissors  
16 cm,



**SI-5-223-17**

**Doyen**

Gynecological Scissors  
18.5 cm,



**SI-5-224-24**

**Sims-Siebold**

Gynecological Scissors  
24.5 cm,



**SI-5-225-24**

**Sims-Siebold**

Gynecological Scissors  
24.5 cm,



**SI-5-226-23**

**Wertheim**

Gynecological Scissors  
20 cm, 23 cm,



**SI-5-227-11**

**Metzenbaum**

Dissecting Scissors  
11.5 cm,



**SI-5-228-14**

**Metzenbaum**

Dissecting Scissors  
14.5 cm,



**SI-5-229-15**

**Metzenbaum**

Dissecting Scissors  
15.5 cm,



**SI-5-230-20**

**Metzenbaum-Nelson**

Dissecting Scissors  
18 cm, 20.5 cm, 23 cm, 26 cm, 28.5 cm, 31 cm,



**SI-5-231-20**

**Metzenbaum-Nelson**

Dissecting Scissors  
18 cm, 20.5 cm,

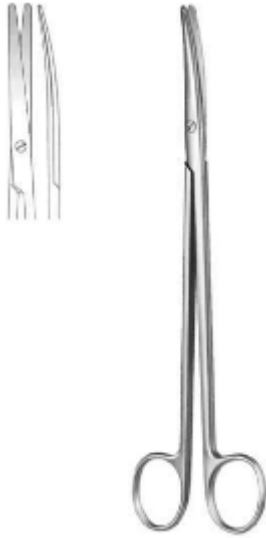

**SI-5-232-20**

**Metzenbaum-Nelson**

Dissecting Scissors

18 cm, 20.5 cm, 23 cm, 26 cm, 28.5 cm, 31 cm,



**SI-5-233-14**

**Metzenbaum**

Dissecting Scissors toothed

14.5 cm,



**SI-5-234-15**

**Nerve Operating Scissor**

Dissecting Scissors

15.5 cm,

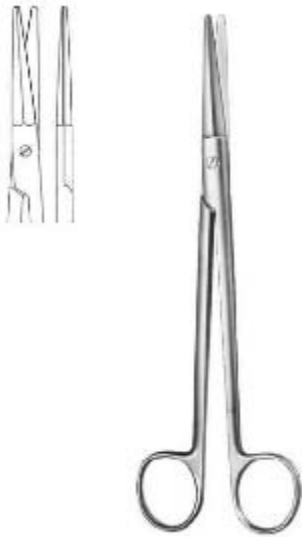

**SI-5-235-19**

**Gorney**

Face-lift Scissors str.

12.5 cm, 19.5 cm,

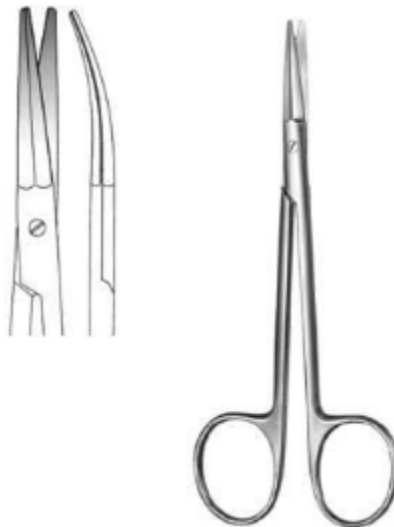

**SI-5-236-19**

**Gorney**

Face-lift Scissors cur.

19.5 cm,



**SI-5-237-17**

**Aston**

Face-lift Scissors

17 cm,





**SI-5-238-16**

**Lexer**

Dissecting Scissors  
16 cm,



**SI-5-239-14**

**Cinelli**

Nasal Scissors  
11.5 cm, 14 cm,



**SI-5-240-19**

**Thorek**

Dissecting Scissors  
18.5 cm,



**SI-5-241-10**

**Lexer-Baby**

Dissecting Scissors  
10 cm,



**SI-5-242-16**

**Lexer-Fino**

Delicate Dissecting Scissors slender  
pattern  
16.5 cm,



**SI-5-243-14**

**Metzenbaum-Fino**

Delicate Dissecting Scissors slender  
pattern  
14.5 cm,



**SI-5-244-14**

**Metzenbaum-Fino**

Delicate Dissecting Scissors  
14.5 cm,



**SI-5-245-14**

**Metzenbaum-Fino**

Delicate Dissecting Scissors  
14.5 cm,



**SI-5-246-14**

**Metzenbaum-Fino**

Delicate Dissecting Scissors  
14.5 cm,

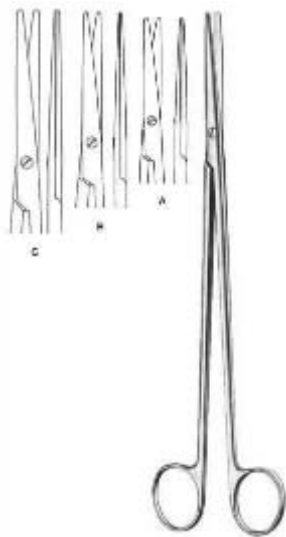

**SI-5-247-18**

**Metzenbaum-Fino**

Delicate Dissecting Scissors slender  
pattern  
18 cm, 20 cm, 23 cm,

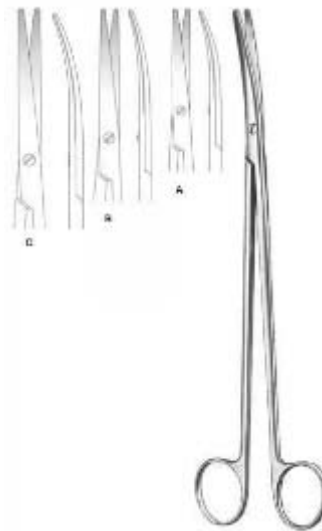

**SI-5-248-18**

**Metzenbaum-Fino**

Delicate Dissecting Scissors slender  
pattern  
18 cm, 20 cm, 23 cm,

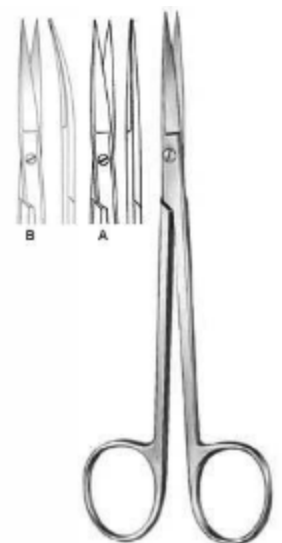

**SI-5-250-14**

**Sanvenero**

Operating Scissors  
14 cm,

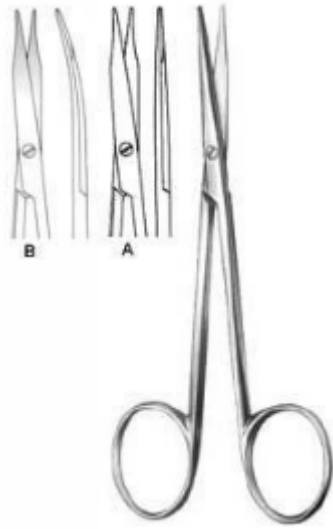

**SI-5-251-11**

Fine Operating Scissors  
11.5 cm,

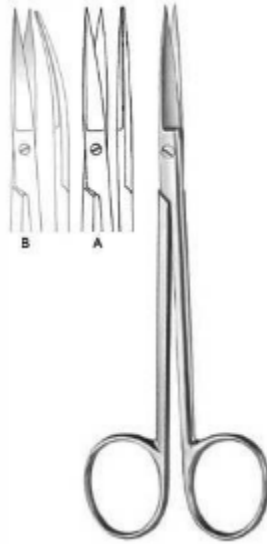

**SI-5-252-14**

**Joseph**  
Operating Scissors  
14.5 cm,

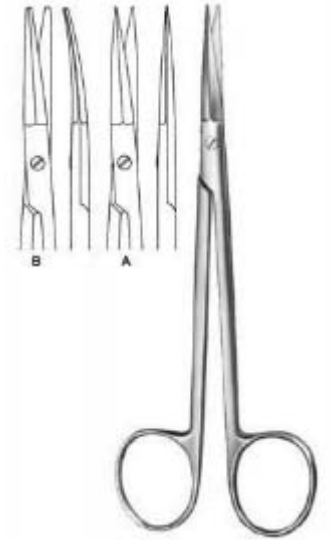

**SI-5-253-14**

**Peck-Joseph**  
Face-lift Scissors  
14.5 cm,

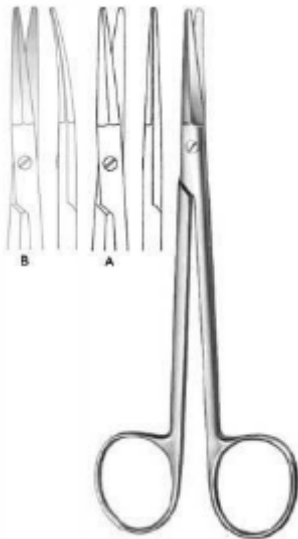

**SI-5-254-14**

**Peck-Joseph**  
Face-lift Scissors  
14.5 cm,



**SI-5-255-12**

**Shea Vein Graft**  
Dissecting Scissors  
12 cm,

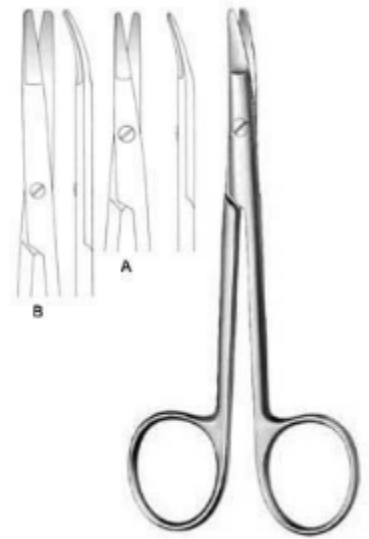

**SI-5-256-12**

**Kilner**  
Dissecting Scissors  
12 cm, 15 cm,

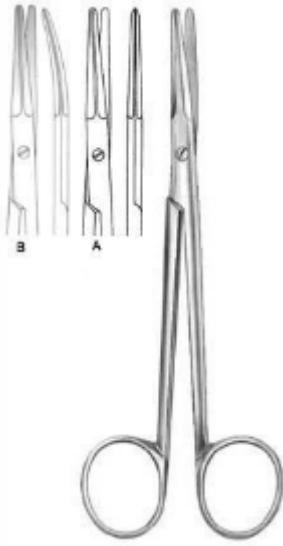

**SI-5-257-14**

Dissecting Scissors  
14.5 cm,

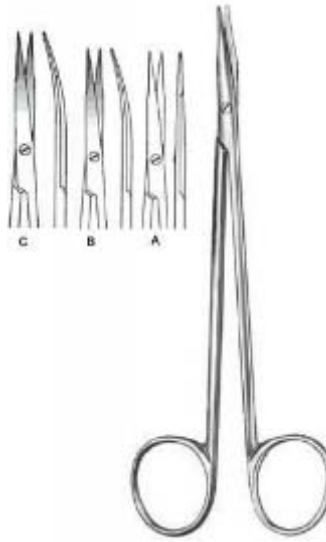

**SI-5-258-15**

**Reynolds**  
Dissecting Scissors  
15.5 cm, 18 cm,



**SI-5-259-14**

**Jameson**  
Dissecting Scissors  
15.5 cm,



**SI-5-260-14**

**Jameson**  
Dissecting Scissors  
15.5 cm,



**SI-5-261-19**

Vascular Scissors  
19 cm,

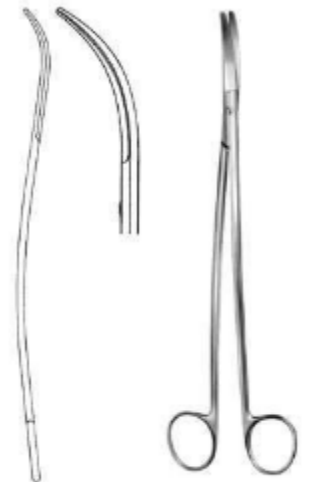

**SI-5-262-24**

Vascular Scissors fine, short blades  
19 cm, 25.5 cm,

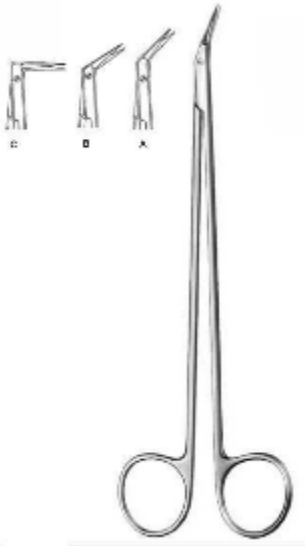

**SI-5-263-25**

**Diethrich**

Vascular Scissors  
19 cm, 18.5 cm, 17.5 cm,

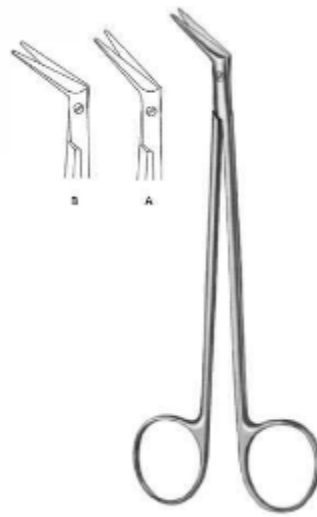

**SI-5-264-45**

**DeBakey**

Vascular Scissors  
16.5 cm, 16 cm,



**SI-5-265-19**

**Potts-Smith**

Vascular Scissors  
18 cm, 18.5 cm, 19 cm,



**SI-5-266-25**

**Coronary Scissors**

Cardiovascular Surgery Scissor  
18 cm,



**SI-5-267-45**

**Coronary Scissors**

Cardiovascular Surgery Scissors  
18 cm,



**SI-5-268-60**

**Coronary Scissors**

Cardiovascular Surgery Scissor  
18 cm,



**SI-5-269-90**

**Coronary Scissors**

Cardiovascular Surgery Scissor  
18 cm,



**SI-5-270-00**

**Coronary Scissors**

Cardiovascular Surgery Scissor  
18 cm,



**SI-5-271-00**

**Coronary Scissors**

Cardiovascular Surgery Scissor  
18 cm,



**SI-5-272-25**

**Coronary Scissors**

Cardiovascular Surgery Scissor  
18 cm,



**SI-5-273-45**

**Coronary Scissors**

Cardiovascular Surgery Scissor  
18 cm,



**SI-5-274-90**

**Coronary Scissors**

Cardiovascular Surgery Scissor  
18 cm,



**SI-5-275-17**

**Schmieden-Taylor**

Dura Scissors  
15 cm,



**SI-5-276-22**

**Strully**

Neurosurgical Scissors  
22.5 cm,



**SI-5-277-17**

**Toennis-Adson**

Dissecting Scissors  
17.5 cm,



**SI-5-279-19**

**Good**

Tonsil Scissors  
19.5 cm,



**SI-5-282-15**

**Fomon**

Nasal Scissors  
15 cm,



**SI-5-283-16**

**Cottle**

Nasal Scissors  
16 cm,



**SI-5-284-18**

**Heymann**

Nasal Scissors  
18.5 cm,



**SI-5-285-18**

**Heymann**

Nasal Scissors  
18.5 cm,



**SI-5-286-11**

**Converse**

Nasal Scissors blunt & sharp  
10.5 cm,



**SI-5-287-18**

**Waldmann**

Episiotomy Scissors  
18 cm,



**SI-5-288-14**

**Braun-Stadler**

Episiotomy Scissors  
14.5 cm,



**SI-5-289-22**

**Braun-Stadler**

Episiotomy Scissors  
22 cm,





**SI-5-290-10**  
**Modell USA**  
Umbilical Scissors  
10.5 cm,



**SI-5-292-16**  
**Busch**  
Umbilical Scissors  
16 cm,



**SI-5-293-13**  
**Goldmann-Fox**  
Gum Scissors  
13 cm,



**SI-5-294-12**  
**Wagner**  
Operating Scissors  
12 cm,

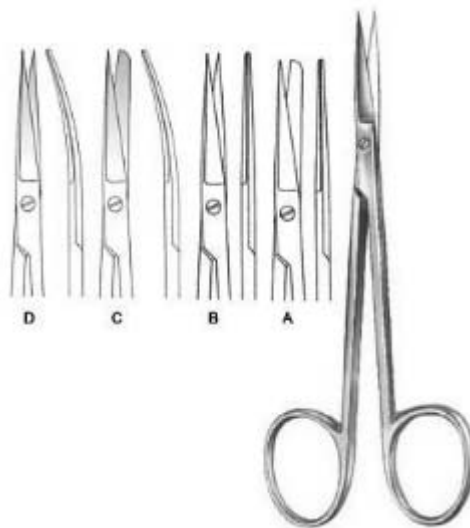

**SI-5-295-12**  
Operating Scissors small model  
12 cm,



**SI-5-296-11**  
**La Grange**  
Gum Scissors S-shaped  
11.5 cm,



**SI-5-297-11**

Dissecting Scissors delicate  
11.5 cm,



**SI-5-298-16**

**Locklin**  
Gum Scissors  
16 cm,



**SI-5-299-16**

**Locklin**  
Gum Scissors  
16 cm,



**SI-5-300-08**

Operating Scissors very delicate  
9 cm,

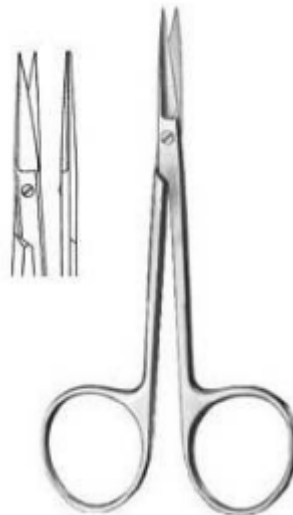

**SI-5-301-10**

Iris Scissors  
9 cm, 10 cm,

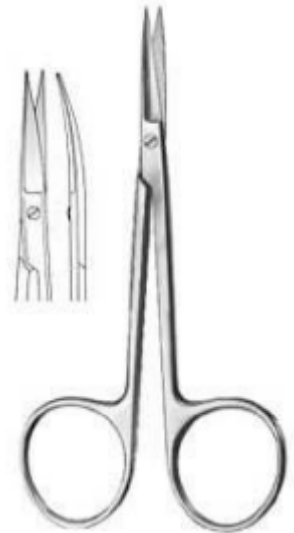

**SI-5-302-10**

Iris Scissors extra flat blades  
10 cm,



**SI-5-303-10**

Iris Scissors extra flat blades  
10 cm,



**SI-5-304-09**

**Bonn**  
Iris Scissors



**SI-5-278-17**

**Dean**  
Tonsil Scissors  
17.5 cm,



**SI-0-**

**Spencer Scissor**



**SI-5-401-10**

**Standard**

Dressing Forceps

10.5 cm, 11.5 cm, 13 cm, 14.5 cm, 16 cm, 18 cm, 20 cm, 23 cm, 25 cm, 30.5 cm,



**SI-5-402-11**

**Standard**

Dressing Forceps

12 cm, 13 cm, 14.5 cm, 16 cm, 18 cm, 20 cm, 25 cm, 30 cm,



**SI-5-403-13**

Dressing Forceps  
13 cm, 14.5 cm,



**SI-5-404-15**

**Stille**

Dressing Forceps

15 cm,



**SI-5-405-12**

**Mini-Adson**

Dressing Forceps

12 cm,



**SI-5-406-12**

**Adson**

Dressing Forceps

12 cm, 15 cm,



**SI-5-407-15**

**McIndoe**

Dressing Forceps  
15 cm,



**SI-5-408-20**

**Waugh**

Dressing Forceps  
20 cm,



**SI-5-409-12**

**Semken**

Dressing Forceps  
12.5 cm, 15 cm,



**SI-5-410-17**

**Taylor**

Dressing Forceps  
12.5 cm, 15 cm,



**SI-5-411-17**

**Taylor**

Dressing Forceps  
17 cm,



**SI-5-412-17**

**Taylor**

Dressing Forceps  
18.5 cm,



**SI-5-413-06**

Micro Dressing Forceps  
15.5 cm,



**SI-5-414-18**

**Gerald**  
Dressing Forceps  
15.5 cm,



**SI-5-415-17**

**Cushing**  
Dressing Forceps  
17.5 cm,



**SI-5-416-18**

**Potts-Smith**  
Dressing Forceps  
18 cm, 21 cm, 24.5 cm,



**SI-5-417-17**

**Bonney**  
Dissecting Forceps  
17.5 cm,



**SI-5-418-17**

**Gerald**  
Dissecting Forceps  
17.5 cm,



**SI-5-419-15**

**Gillies**

Dissecting Forceps  
15.5 cm,



**SI-5-420-15**

**McIndoe**

Dressing Forceps  
15 cm,



**SI-5-421-16**

**Semken**

Dissecting Forceps  
15.5 cm, 17.5 cm,



**SI-5-422-12**

**Adson-Brown**

Dissecting Forceps  
12 cm,



**SI-5-423-12**

**Adson**

Dissecting Forceps  
12 cm, 15 cm,



**SI-5-424-12**

**Adson**

Dressing Forceps  
12 cm, 15 cm,



**SI-5-425-17**

**Cushing**

Dressing Forceps  
17.5 cm,



**SI-5-426-18**

**Cushing**

Dressing Forceps  
17 cm,



**SI-5-427-18**

**Cushing-Taylor**

Dressing Forceps  
18.5 cm,



**SI-5-428-15**

**Potts-Smith**

Dressing Forceps  
16 cm, 18.5 cm, 20 cm, 23 cm, 25 cm,



**SI-5-429-14**

**Oehler**

Dissecting Forceps  
14.5 cm, 16 cm, 18 cm, 20 cm, 25 cm,



**SI-5-430-15**

**Wangensteen**

Dressing Forceps  
15 cm, 23 cm,





**SI-5-431-15**

**DeBakey**

Atraumatic Dressing Forceps  
16 cm, 20 cm, 24.5 cm, 16 cm, 20 cm, 24.5 cm,



**SI-5-432-16**

**DeBakey**

Atraumatic Dressing Forceps  
16 cm, 20 cm, 24 cm,



**SI-5-433-10**

**Dissecting Forceps**

10.5 cm, 11.5 cm, 13 cm, 14.5 cm, 16 cm, 18 cm, 20 cm, 23 cm, 25 cm, 30.5 cm,

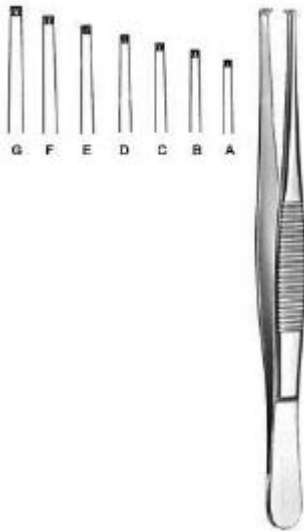

**SI-5-434-11**

**Dissecting Forceps**

12 cm, 13 cm, 14.5 cm, 15.5 cm, 18 cm, 20 cm, 24.5 cm,



**SI-5-435-14**

**Dissecting Forceps**

14.5 cm, 16 cm,



**SI-5-436-14**

**Dissecting Forceps**

14.5 cm, 16 cm,



**SI-5-437-13**

Dissecting Forceps  
13 cm, 14.5 cm, 16 cm, 20 cm,



**SI-5-438-13**

Dissecting Forceps  
13 cm, 14.5 cm,



**SI-5-439-15**

**Stille**  
Dissecting Forceps  
15 cm,



**SI-5-440-15**

**Stille**  
Dissecting Forceps  
15 cm,



**SI-5-441-15**

**Stone**  
Dissecting Forceps  
15 cm,



**SI-5-442-15**

**Lerche**  
Dissecting Forceps  
15 cm,



**SI-5-443-15**

**Adlerkreutz**

Dissecting Forceps

15.5 cm, 20.5 cm, 16 cm, 20 cm, 25 cm,

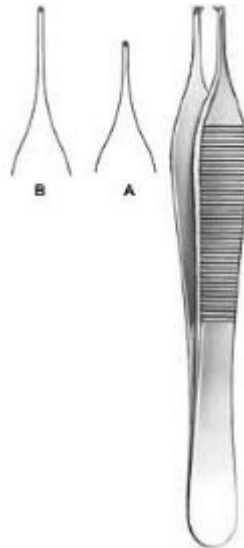

**SI-5-444-12**

**Adson**

Dissecting Forceps

12 cm, 15 cm,



**SI-5-445-15**

**Gillies**

Dissecting Forceps

15.5 cm,



**SI-5-446-20**

**Waugh**

Dissecting Forceps

20.5 cm,



**SI-5-447-12**

**Semken**

Dissecting Forceps

12.5 cm, 15 cm,



**SI-5-448-17**

**Taylor**

Dissecting Forceps

17.5 cm,



**SI-5-449-17**

**Taylor**

Dissecting Forceps  
17 cm,



**SI-5-450-17**

**Taylor**

Dissecting Forceps  
18.5 cm,



**SI-5-451-06**

Micro Dissecting Forceps  
15.5 cm,



**SI-5-452-17**

**Gerald**

Dissecting Forceps  
17.5 cm,



**SI-5-453-17**

**Cushing**

Dissecting Forceps  
18 cm,



**SI-5-454-18**

**Potts-Smith**

Dissecting Forceps  
18 cm, 21 cm, 24 cm,

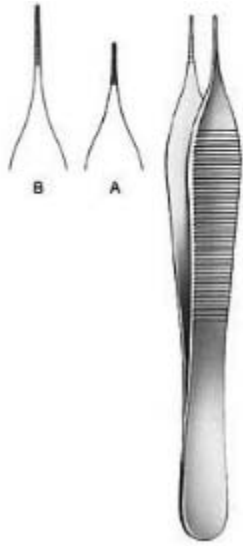

**SI-5-455-12**

**Mikro-Adson**

Dressing Forceps  
12 cm, 15 cm,

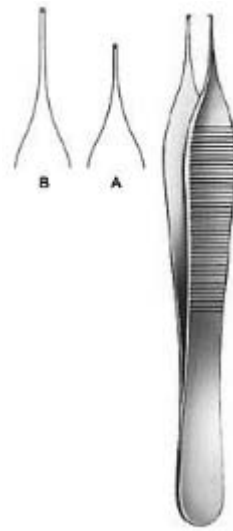

**SI-5-456-12**

**Mikro-Adson**

Dissecting Forceps  
12 cm, 15 cm,



**SI-5-457-11**

Dissecting Forceps  
10.5 cm,



**SI-5-458-12**

**Micro Jewelers**

Jeweler Type Forceps  
12 cm Fig. 7,



**SI-5-459-12**

**Jewelers**

Jeweler Type Forceps  
12 cm Fig. 3,



**SI-5-460-11**

**Jewelers**

Jeweler Type Forceps  
11 cm Fig. 3c,



**SI-5-461-11**

**Jewelers**

Jeweler Type Forceps  
11 cm Fig. 5,



**SI-5-462-11**

**Jewelers**

Jeweler Type Forceps  
11 cm Fig. 4,



**SI-5-463-18**

**Stille-Barraya**

Dissecting Forceps  
18 cm,



**SI-5-464-18**

**Bonney**

Dissecting Forceps  
17.5 cm,



**SI-5-465-23**

**Nelson**

Dissecting Forceps  
23 cm,



**SI-5-466-10**

Dressing Forceps  
10 cm, 9.5 cm,



**SI-5-467-12**

Splinter Forceps smooth jaw  
12.5 cm,



**SI-5-468-12**

Splinter Forceps smooth jaw  
12.5 cm,



**SI-5-469-12**

Splinter Forceps  
12.5 cm,



**SI-5-470-12**

Splinter Forceps  
12.5 cm,



**SI-5-471-16**

Micro Tying Forceps  
15.5 cm,



**SI-5-472-10**

Microscopic Forceps super light, blunt  
10 cm,



**SI-5-473-10**

Microscopic Forceps  
10 cm,



**SI-5-474-09**

**Shaaf**  
Splinter Forceps  
9.5 cm,



**SI-5-475-08**

**Littauer**  
Cilia Forceps  
8.5 cm,



**SI-5-476-09**

Cilia Forceps  
8.5 cm,



**SI-5-477-09**

**Douglas**  
Cilia Forceps  
9 cm,



**SI-5-478-09**

**Douglas**  
Cilia Forceps  
9 cm,





**SI-5-479-09**

**Beer**

Cilia Forceps  
9 cm,



**SI-5-501-21**

**Phaneuf**

Hysterectomy Forceps  
20.5 cm,



**SI-5-502-21**

**Wertheim-Cullen**

Vaginal Clamp  
21 cm,

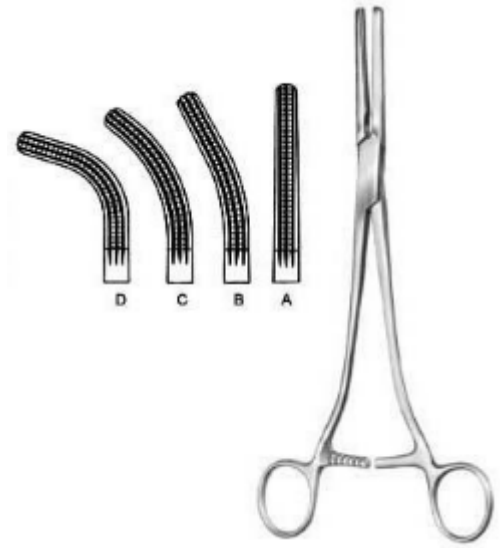

**SI-5-503-10**

**Rogers**

Hysterectomy Forceps  
21.5 cm Fig. 1, 21 cm Fig. 2, 20.5 cm Fig. 3, 20 cm Fig. 4,



**SI-5-504-23**

**Moynihan**

Hysterectomy Forceps  
23 cm,



**SI-5-505-24**

**Moynihan**

Hysterectomy Forceps  
23.5 cm,



**SI-5-506-25**

**Wertheim**

Hysterectomy Forceps  
26 cm,

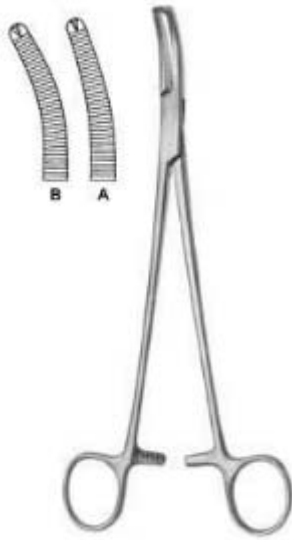

**SI-5-507-22**

**Wertheim**

Hysterectomy Forceps  
22.5 cm,



**SI-5-508-14**

**Mikulicz, Baby**

Peritoneum Forceps  
14.5 cm,



**SI-5-509-18**

**Mikulicz**

Peritoneum Forceps  
20.5 cm,



**SI-5-510-20**

**Mikulicz**

Peritoneum Forceps  
18.5 cm,



**SI-5-511-20**

**Mikulicz**

Peritoneum Forceps  
20 cm,



**SI-5-512-21**

**Mikulicz**

Peritoneum Forceps  
20.5 cm,



**SI-5-513-20**

**Faure**

Peritoneum Forceps  
21 cm,

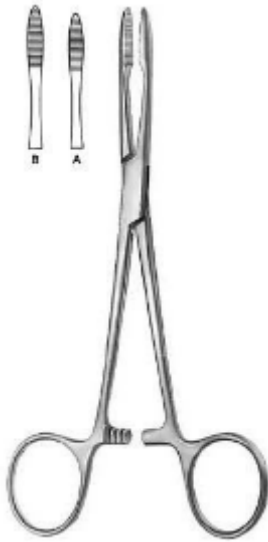

**SI-5-601-14**

**Pean**

Haemostatic Forceps  
14.5 cm, 16 cm,



**SI-5-602-13**

**Spencer-Wells**

Haemostatic Forceps  
13 cm, 14 cm, 15.5 cm, 18.5 cm, 20 cm,



**SI-5-603-13**

**Spencer-Wells**

Haemostatic Forceps  
13 cm, 14 cm, 15 cm, 18 cm, 20 cm,



**SI-5-604-13**

**Chaput**

Haemostatic Forceps  
12.5 cm,



**SI-5-605-13**

**Tuffier**

Haemostatic Forceps  
12.5 cm,

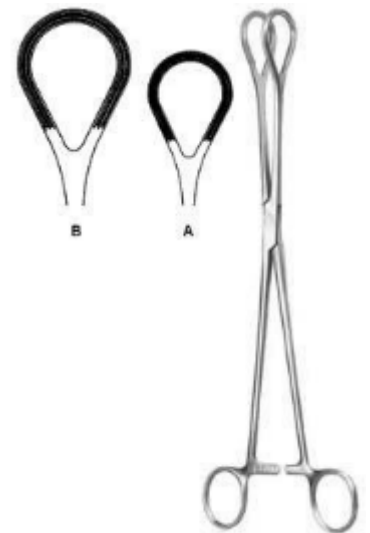

**SI-5-606-25**

Organ Grasping Forceps



**SI-5-607-14**

**Collin**

Organ Grasping Forceps  
15.5 cm, 21 cm,



**SI-5-608-17**

**Collin**

Tumor Grasping Forceps  
17 cm,



**SI-5-609-15**

**Pennington**

Haemostatic Forceps  
15.5 cm,



**SI-5-610-15**

**Pratt**

Haemostatic Forceps  
15 cm,



**SI-5-611-14**

**Martel-Rees**

Face-lift Forceps  
13.5 cm,



**SI-5-612-12**

Ligature Forceps



**SI-5-613-01**

**Mixer-Baby**

Dissecting and Ligature Forceps  
13.5 cm, 13 cm,

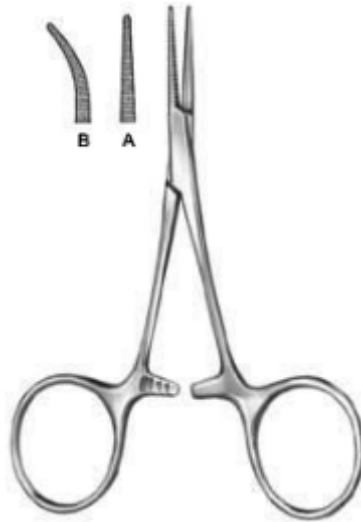

**SI-5-614-10**

**Hartmann**

Haemostatic Forceps  
10 cm, 9.5 cm,



**SI-5-615-12**

Ligature Forceps

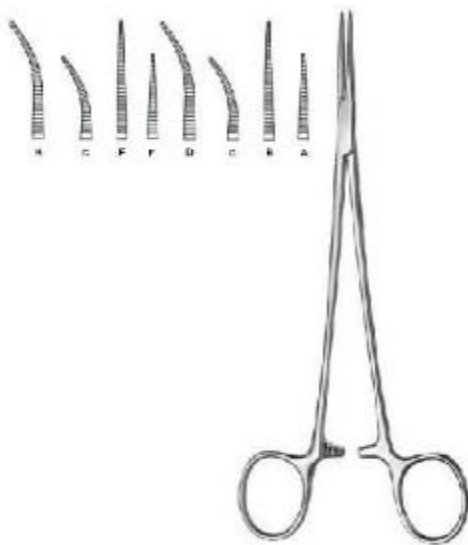

**SI-5-616-18**

**Halsted-Mosquito**

Haemostatic Forceps  
12.5 cm, 14.5 cm, 14 cm,



**SI-5-617-10**

**Mikro-Mosquito**

Haemostatic Forceps  
10 cm, 12 cm, 9.5 cm, 11.5 cm,



**SI-5-618-14**

**Providence-Hospital**

Haemostatic Forceps  
14 cm,



**SI-5-619-15**

**Leriche**

Haemostatic Forceps  
15.5 cm, 15 cm,

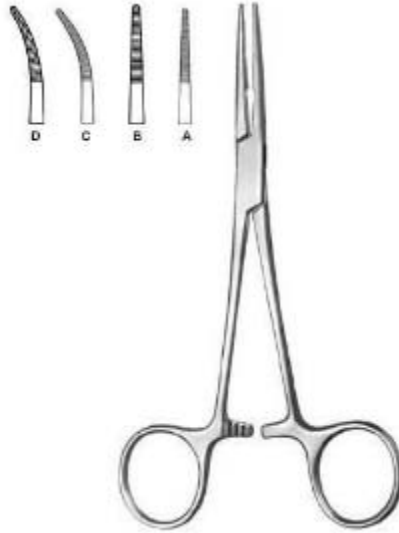

**SI-5-620-14**

**Kelly**

Haemostatic Forceps  
14.5 cm, 14 cm,



**SI-5-621-16**

**Kelly-Rankin**

Haemostatic Forceps  
16 cm, 15.5 cm,



**SI-5-622-14**

**Overholt-Baby**

Dissecting and Ligature Forceps  
14.5 cm, 14 cm,



**SI-5-623-14**

**Crile**

Haemostatic Forceps  
14.5 cm, 14 cm,



**SI-5-624-16**

**Crile-Rankin**

Haemostatic Forceps  
16.5 cm, 16 cm,





**SI-5-625-15**

**Lovelace**

Haemostatic Forceps  
16 cm,



**SI-5-626-12**

**Dandy-Mosquito**

Haemostatic Forceps  
12 cm,

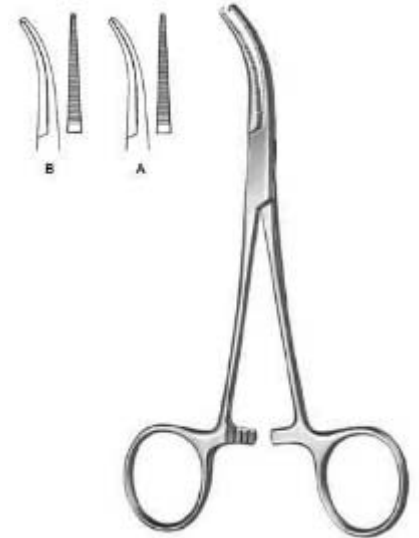

**SI-5-627-14**

**Dandy**

Haemostatic Forceps  
14.5 cm, 14 cm,



**SI-5-628-18**

**Schnidt**

Dissecting and Ligature Forceps  
18.5 cm, 19 cm,



**SI-5-629-18**

**Adson**

Dissecting and Ligature Forceps  
19 cm, 18.5 cm,



**SI-5-630-20**

**Martin-Fuchsig**

Dissecting and Ligature Forceps  
20.5 cm,

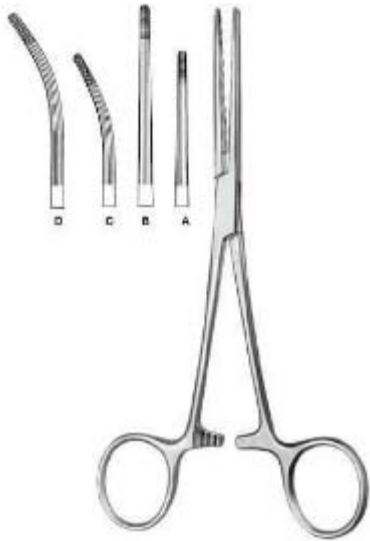

SI-5-631-16

**Rochester-Carmalt**

Haemostatic Forceps  
17 cm, 20.5 cm, 16.5 cm, 20 cm,

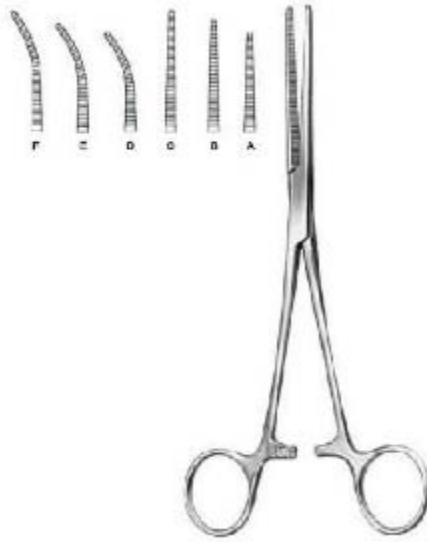

SI-5-632-13

**Pean**

Haemostatic Forceps  
13.5 cm, 14.5 cm, 17 cm, 13 cm, 14 cm, 16.5 cm,

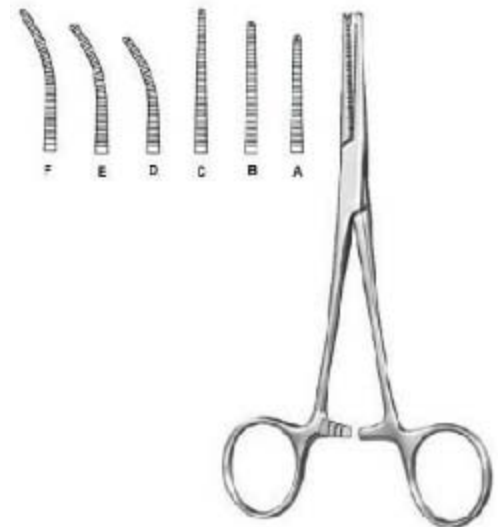

SI-5-633-14

**Kocher-Nippon**

Haemostatic Forceps  
14.5 cm, 16.5 cm, 18.5 cm, 16 cm, 18 cm,

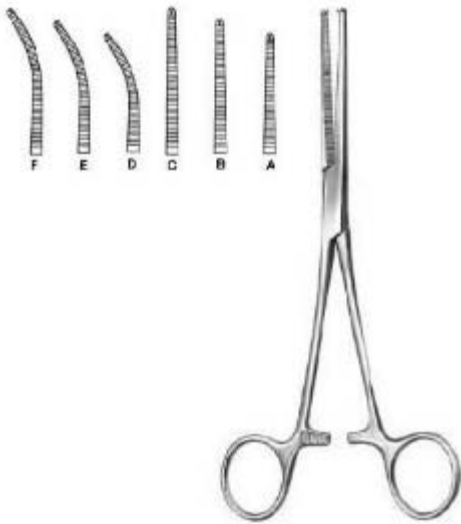

SI-5-635-13

**Kocher**

Haemostatic Forceps  
13 cm, 14 cm, 16 cm,

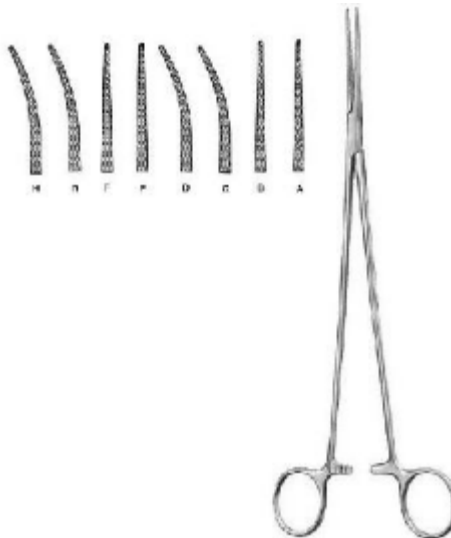

SI-5-636-20

**Bengolea**

Haemostatic Forceps  
21.5 cm, 26 cm, 21 cm, 21.5 cm,

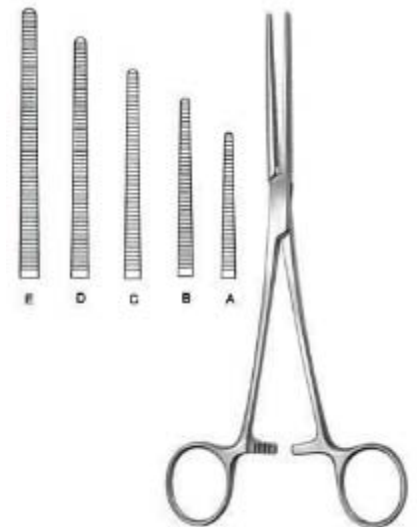

SI-5-637-14

**Pean (Rochester)**

Haemostatic Forceps  
14.5 cm, 16.5 cm, 18.5 cm, 20.5 cm, 22.5 cm, 24.5 cm, 26 cm, 30.5 cm, 14 cm, 16 cm,

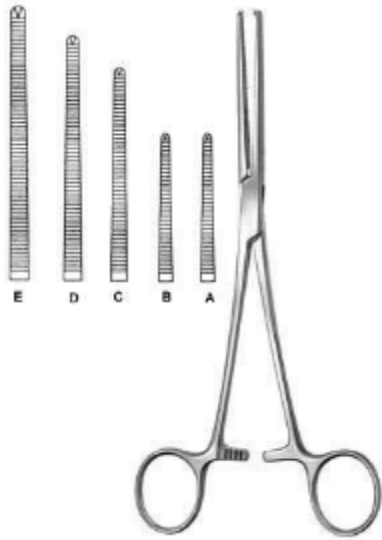

**SI-5-638-14**

**Kocher (Ochsner)**

Haemostatic Forceps

14.5 cm, 16.5 cm, 18.5 cm, 20.5 cm, 22.5 cm, 24.5 cm, 26 cm, 30.5 cm,

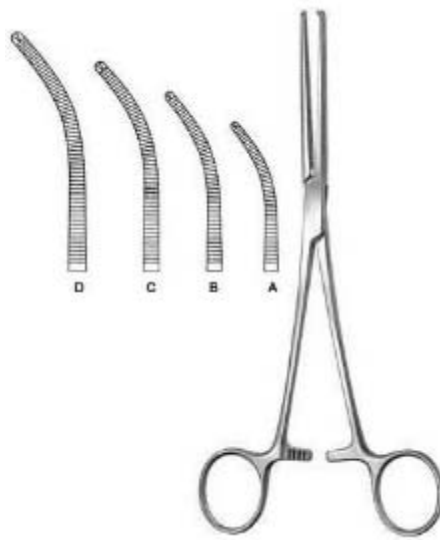

**SI-5-639-14**

**Kocher (Ochsner)**

Haemostatic Forceps

14 cm, 16 cm, 18 cm, 20 cm, 22 cm, 24 cm, 25.5 cm, 30 cm,

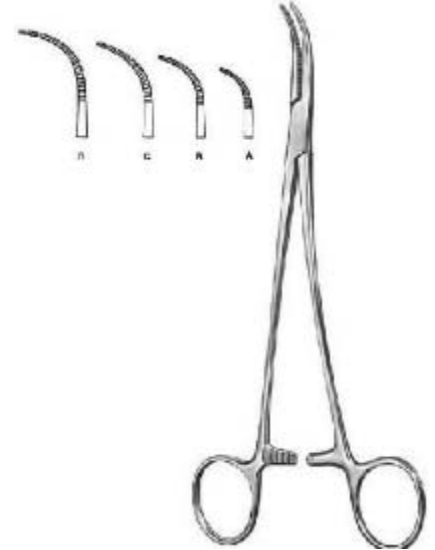

**SI-5-640-01**

**Overholt-Martin**

Dissecting and Ligature Forceps

18.5 cm Fig. 1, 20.5 cm Fig. 2, 21 cm Fig. 3, 21.5 cm Fig. 4, 24.5 cm Fig. 5,



**SI-5-641-18**

**Mixer-Baby**

Dissecting and Ligature Forceps

18.5 cm,



**SI-5-642-14**

**Adson-Baby**

Dissecting and Ligature Forceps

14.5 cm, 18 cm,



**SI-5-643-20**

**Heiss**

Dissecting and Ligature Forceps

21 cm, 20.5 cm, 20 cm,



**SI-5-644-21**

**Overholt-Mixer**

Dissecting and Ligature Forceps  
21.5 cm,

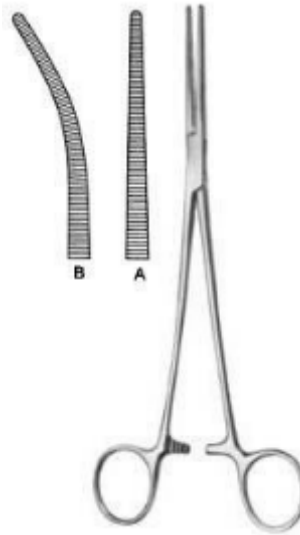

**SI-5-645-22**

**Roberts**

Dissecting and Ligature Forceps  
22.5 cm, 21.5 cm,

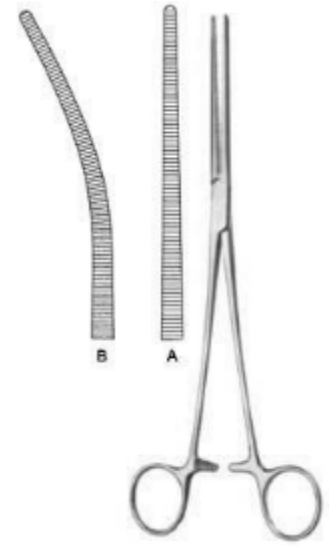

**SI-5-646-24**

**Sarot**

Dissecting and Ligature Forceps  
25 cm, 24.5 cm,



**SI-5-647-18**

**Crafoord**

Dissecting and Ligature Forceps  
18 cm, 24.5 cm,

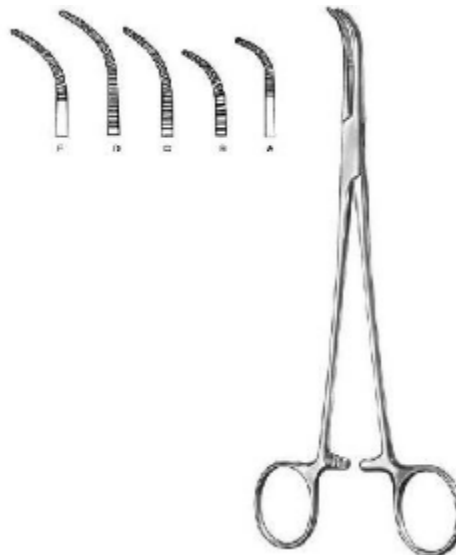

**SI-5-648-01**

**Overholt-Geissendorfer**

Dissecting and Ligature Forceps  
20.5 cm Fig. 1, 20 cm Fig. 2, 21.5 cm Fig. 3, 22 cm Fig. 4, 21.5 cm Fig. 5, 22 cm Fig. 6, 27 cm Fig. 1, 26.5 cm Fig. 2, 27.5 cm Fig. 3, 28 cm Fig. 4,

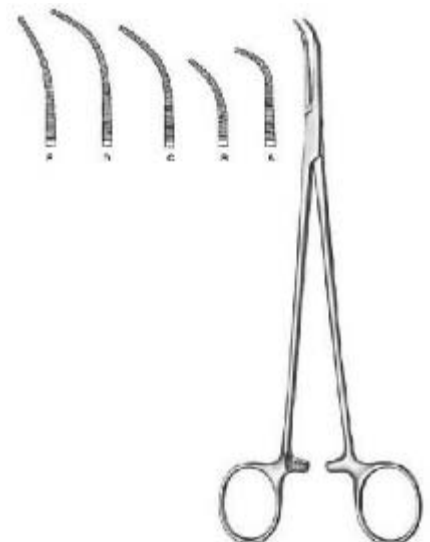

**SI-5-649-00**

**Overholt-Fino**

Dissecting and Ligature Forceps  
21.5 cm, 21 cm, 22 cm, 23 cm, 22.5 cm,

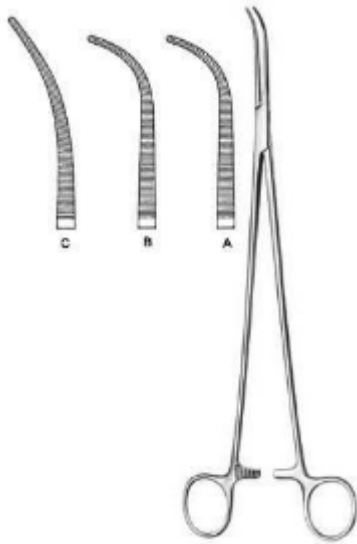

**SI-5-650-00**

**Overholt**

Dissecting and Ligature Forceps  
29.5 cm, 30 cm,



**SI-5-651-01**

**Overholt-Mini**

Dissecting and Ligature Forceps  
15 cm, 20 cm,



**SI-5-652-13**

**Gemini**

Dissecting and Ligature Forceps  
13 cm, 16 cm, 18 cm, 21 cm, 23 cm, 25 cm, 28 cm,

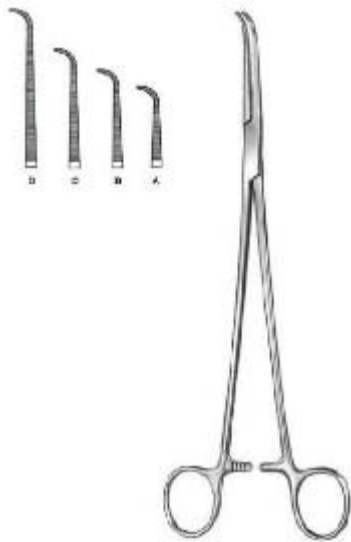

**SI-5-653-18**

**Mini-Gemini**

Dissecting and Ligature Forceps  
18 cm, 22.5 cm, 25 cm, 28.5 cm,

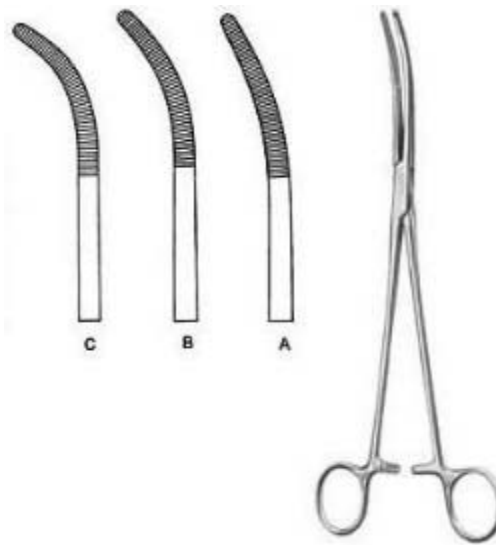

**SI-5-654-01**

**Rumel**

Dissecting and Ligature Forceps  
24 cm Fig. 1, 23.5 cm Fig. 2, 23 cm Fig. 3, 24 cm Fig. 4, 23.5 cm Fig. 5,

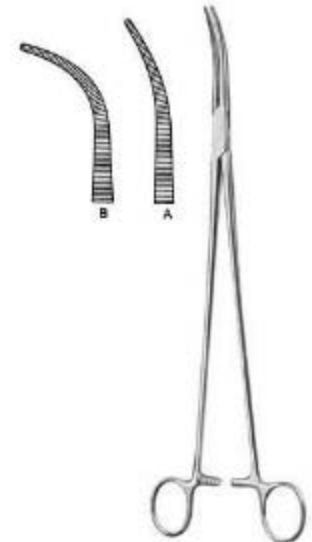

**SI-5-655-01**

**Zenker**

Dissecting and Ligature Forceps  
29.5 cm, 28.5 cm,



**SI-5-656-14**

**Mixer-Baby**

Dissecting and Ligature Forceps  
13.5 cm,



**SI-5-657-15**

**Mixer**

Dissecting and Ligature Forceps  
16 cm, 18 cm,



**SI-5-658-19**

**Mixer-O Shaugnessy**

Dissecting and Ligature Forceps  
18 cm,



**SI-5-659-22**

**Mixer**

Dissecting and Ligature Forceps  
22.5 cm,



**SI-5-660-23**

**Mixer**

Dissecting and Ligature Forceps  
23 cm,



**SI-5-661-21**

**Wickstrom**

Dissecting and Ligature Forceps  
21 cm, 24.5 cm,



**SI-5-662-22**

**Mixer**

Dissecting and Ligature Forceps  
22.5 cm, 26 cm, 28 cm,



**SI-5-663-22**

**Mc Quigg-Mixer**

Dissecting and Ligature Forceps  
23.5 cm,



**SI-5-664-18**

**Lower**

Dissecting and Ligature Forceps  
18.5 cm,



**SI-5-665-19**

**Lahey**

Bile Duct Clamp  
19.5 cm, 22.5 cm,



**SI-5-666-24**

**Finochietto**

Dissecting and Ligature Forceps  
24 cm,



**SI-5-667-01**

**Uro-Tangential**

Tangential Forceps  
25 cm, 27 cm,

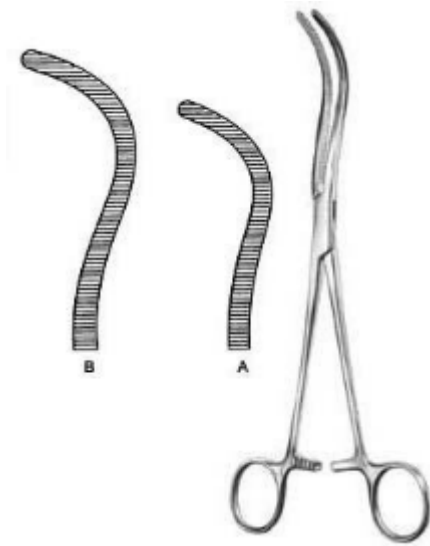

**SI-5-668-20**

**Guyon**

Kidney Pedicle Clamp  
23 cm, 24 cm,



**SI-5-669-23**

**Guyon**

Kidney Pedicle Clamp  
19.5 cm, 21.5 cm, 24 cm,



**SI-5-670-21**

**Desjardins**

Bile Duct Clamp  
21 cm,

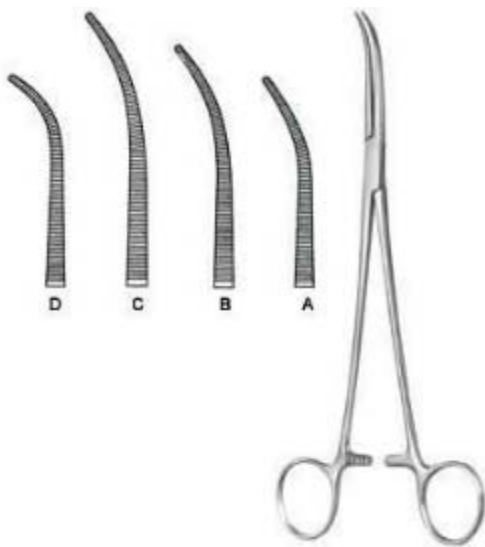

**SI-5-671-19**

**Kelly**

Dissecting and Ligature Forceps  
19.5 cm Fig. 1, 22.5 cm Fig. 1, 24.5 cm Fig. 1, 19  
cm Fig. 2, 22 cm Fig. 2, 24 cm Fig. 2, 18.5 cm Fig.  
3, 21.5 cm Fig. 3, 23.5 cm Fig. 3,



**SI-5-672-28**

**Lawrence**

Dissecting and Ligature Forceps  
28 cm,



**SI-5-673-28**

**Meeker**

Dissecting and Ligature Forceps  
28 cm,





**SI-5-674-19**

**Negus**

Haemostatic Forceps  
19.5 cm Fig. 1, 20 cm Fig. 2,



**SI-5-701-09**

**Schaedel**

Towel Clamp sharp  
9 cm,



**SI-5-702-05**

**Jones**

Towel Clamp sharp  
5.5 cm, 8.5 cm,



**SI-5-703-09**

**Jones-Martin**

Towel Clamp sharp  
8.5 cm,



**SI-5-704-11**

**Backhaus**

Towel Clamp  
11.5 cm, 13 cm,



**SI-5-705-11**

**Backhaus**

Towel Clamp  
11.5 cm,



**SI-5-706-08**

**Backhaus**

Towel Clamp  
9 cm, 11.5 cm, 13 cm, 16 cm,

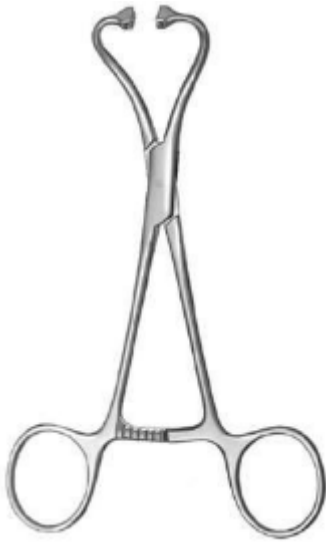

**SI-5-707-15**

**Peers-Bertram modif.**

Towel Clamp wide jaw for tube fixation  
15.5 cm,



**SI-5-708-13**

**R?der**

Towel Clamp  
13.5 cm,

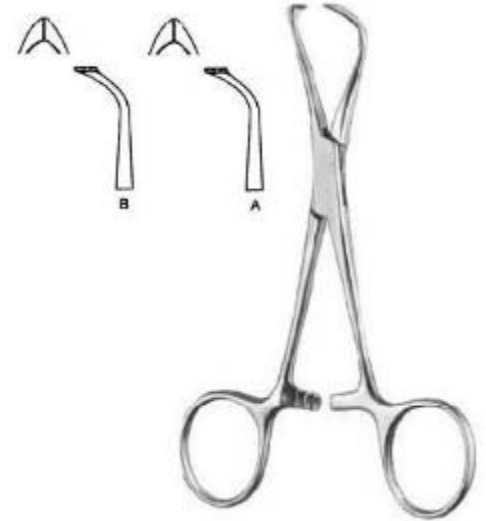

**SI-5-709-10**

**Lorna**

Towel Clamp fine serrated, wide jaw  
9.5 cm, 13 cm,



**SI-5-710-16**

**Bernhard**

Towel Clamp  
16.5 cm,

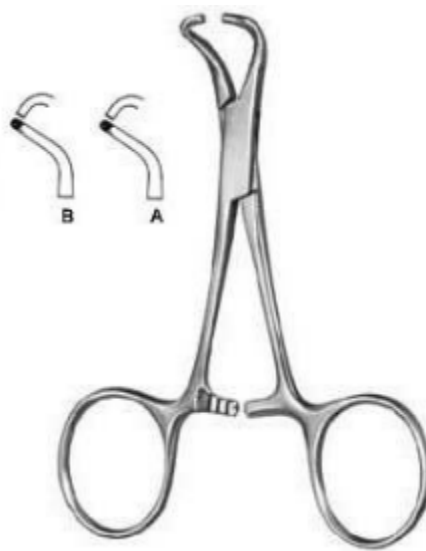

**SI-5-711-10**

**Tohoku**

Towel Clamp  
10.5 cm blunt, 13.5 cm blunt, 14.5 cm,

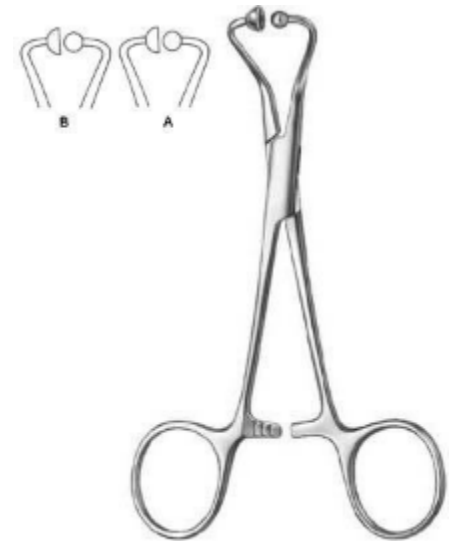

**SI-5-712-11**

Towel Clamp for paper clothes  
11.5 cm, 14 cm,



**SI-5-713-20**

**Lane**

Towel Clamp  
19.5 cm,



**SI-5-714-06**

Tube Holder for fixation of six tubes



**SI-5-715-14**

Tubing Clamp extra long ratchet  
14 cm,



**SI-5-716-16**

Tubing Clamp  
16.5 cm,

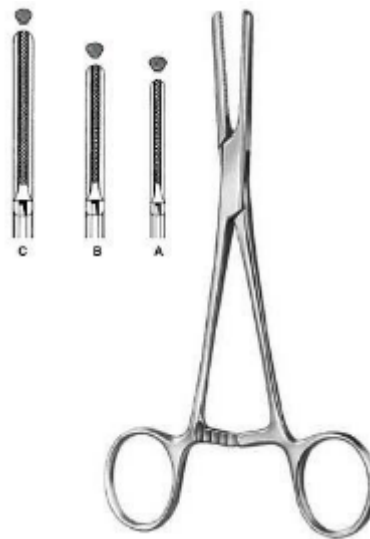

**SI-5-717-15**

Tubing Clamp  
15.5 cm, 19 cm, 20.5 cm,

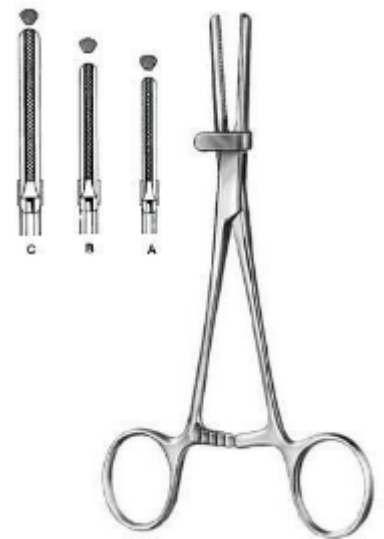

**SI-5-718-15**

Tubing Clamp with safety guard  
15.5 cm, 19 cm, 20.5 cm,

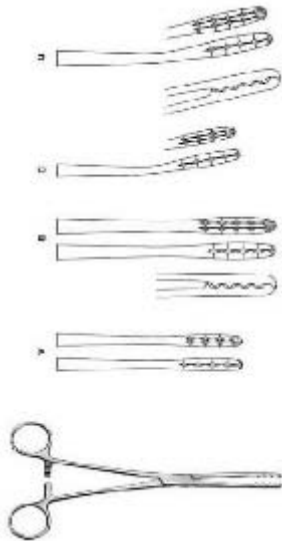

**SI-5-801-22**

**Ulrich**

Dressing Forceps  
22.5 cm, 26.5 cm,



**SI-5-802-13**

**Lister**

Sinus Forceps  
13 cm, 16 cm, 18 cm,



**SI-5-803-17**

**Martin**

Dressing Forceps  
17.5 cm, 17 cm,

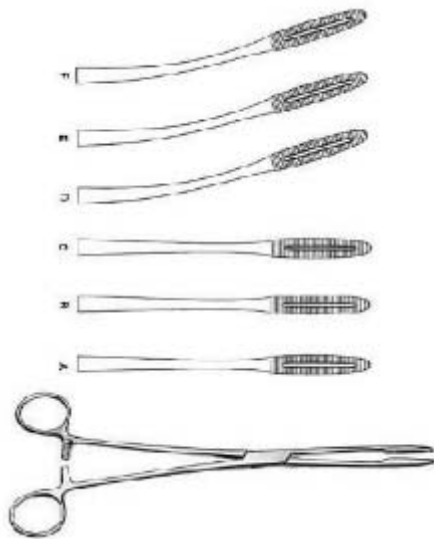

**SI-5-804-20**

**Gross-Maier**

Dressing Forceps  
20.5 cm, 22 cm, 26.5 cm, 20 cm, 21.5 cm, 26 cm,



**SI-5-805-40**

Tunneling Forceps  
39.5 cm,



**SI-5-806-25**

**Collin**

Dressing Forceps  
25.5 cm,



**SI-5-807-25**

**Cheron**

Dressing Forceps  
23.5 cm,



**SI-5-808-26**

**Bozemann**

Sponge Forceps  
26 cm,



**SI-5-809-25**

**Foerster**

Sponge Forceps  
25 cm, 18 cm, 20.5 cm, 24.5 cm, 17.5 cm, 20 cm, 24.5 cm,

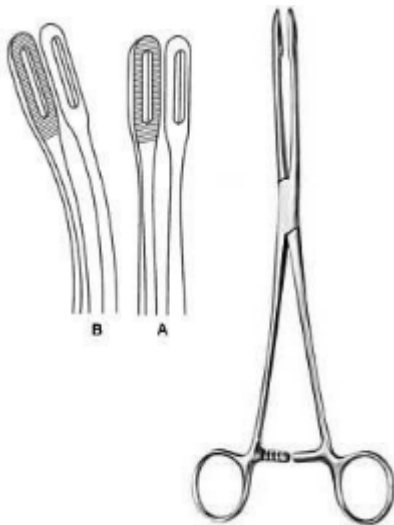

**SI-5-810-25**

**Foerster**

Sponge Forceps  
25 cm, 24.5 cm,

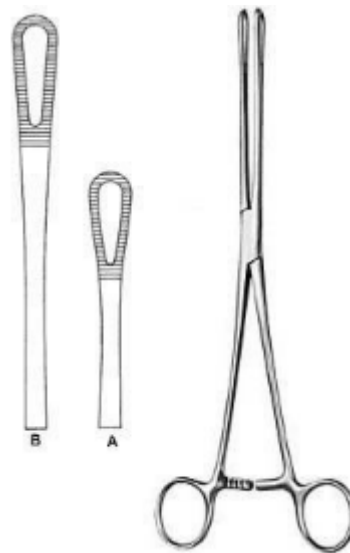

**SI-5-811-18**

**Rampley**

Sponge Forceps  
18.5 cm, 24.5 cm,



**SI-5-901-18**  
**Vickers**  
Skin Hooklet  
18.5 cm,



**SI-5-902-01**  
**Vickers**  
Bone Hooklet  
17 cm,



**SI-5-903-01**  
**Vickers**  
Tendon Hooklet  
17 cm,



**SI-5-904-02**  
**Vickers**  
Hooklet  
16 cm,

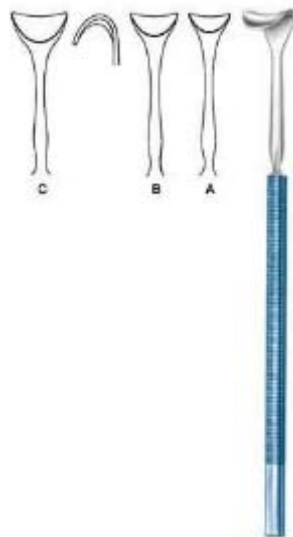

**SI-5-905-12**  
**Vickers**  
Saddle Hook  
14 cm,



**SI-5-906-01**  
**Graefe**  
Micro Hooklet  
15 cm,

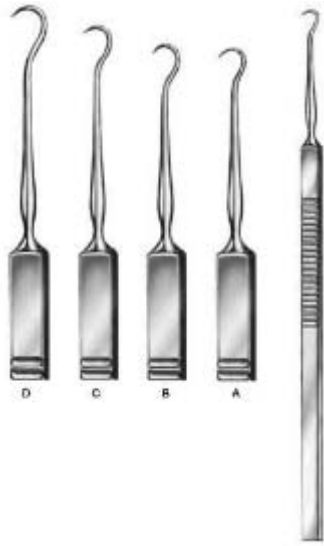

**SI-5-907-01**

Skin Hook  
16 cm Fig. 1, 16 cm Fig. 2, 16 cm Fig. 3, 16 cm Fig. 4,



**SI-5-908-16**

**O Connor**  
Skin Hook  
16 cm,

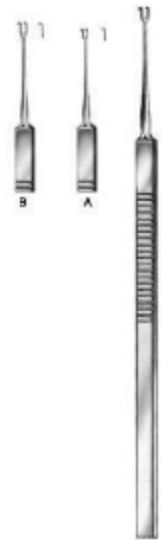

**SI-5-909-01**

**Guthrie**  
Skin Hook  
15.5 cm,



**SI-5-910-01**

Hooklet  
16.5 cm,



**SI-5-911-01**

Hooklet  
16.5 cm,



**SI-5-912-02**

Hooklet  
16 cm,





**SI-5-913-04**

Hooklet  
16.5 cm,



**SI-5-914-12**

Vessel Hook  
12 cm,



**SI-5-915-08**

**Desmarres**

Saddle Hook

16 cm 8 mm, 16 cm 10 mm, 16 cm 12 mm, 16 cm 14 mm, 16 cm 16 mm, 16 cm 18 mm,

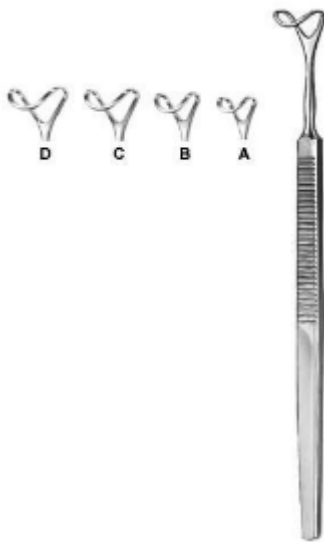

**SI-5-916-12**

Saddle Hook

16 cm 12 mm, 16 cm 14 mm, 16 cm 16 mm, 16 cm 18 mm,



**SI-5-917-10**

**Langenbeck-Mini**

Hooklet  
16 cm,



**SI-5-918-16**

Hooklet  
16 cm 14 x 8,



**SI-5-919-01**

Hooklet  
16.5 cm,



**SI-5-920-01**

Hooklet  
16.5 cm,



**SI-5-921-01**

**Meyerding**

Hooklet  
17.5 cm Fig. 1, 17.5 cm Fig. 2, 17.5 cm  
Fig. 3, 17.5 cm Fig. 4, 17.5 cm Fig. 5, 17.5  
cm Fig. 6,



**SI-5-922-01**

**Senn-Green**

Hooklet  
15 cm Fig. 1, 15 cm Fig. 2,



**SI-5-923-14**

**Ragnell-Davis**

Hooklet  
14 cm,

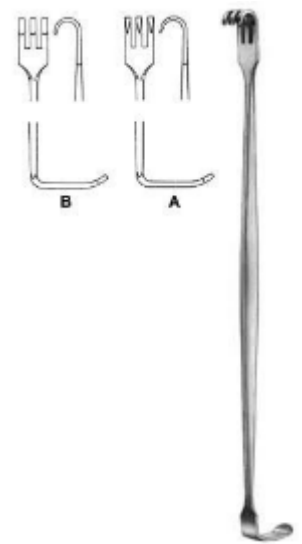

**SI-5-924-16**

**Senn-Miller**

Hooklet  
16 cm,



**SI-5-925-20**

**Cushing**

Retractor  
20.5 cm,



**SI-5-926-08**

**Cushing**

Saddle Hook

20.5 cm 8 mm wide, 20.5 cm 10 mm wide, 20.5 cm 12 mm wide, 20.5 cm 14 mm wide, 20.5 cm 16 mm wide, 20.5 cm 18 mm wide,



**SI-5-927-08**

**Cushing**

Saddle Hook 8 mm to 18 mm wide  
24 cm,



**SI-5-928-01**

**Brom**

Vein Hook  
19.5 cm,



**SI-5-929-01**

**Strandell-Stille**

Hooklet

19 cm Fig. 1, 19 cm Fig. 2,



**SI-5-930-01**

**Klapp**

Retractor 12 x 6, 12 x 11, 15 x 11  
17.5 cm,



**SI-5-931-04**

Hooklet  
16.5 cm,

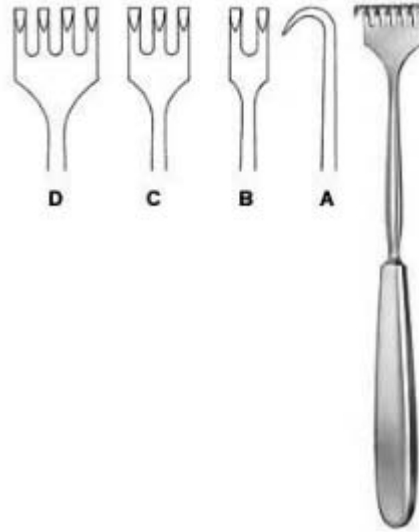

**SI-5-932-01**

**Volkman**  
Retractor  
21.5 cm,



**SI-5-933-01**

**Volkman**  
Retractor  
22 cm, 21.5 cm,



**SI-5-934-01**

**Kocher**  
Retractor  
22 cm,

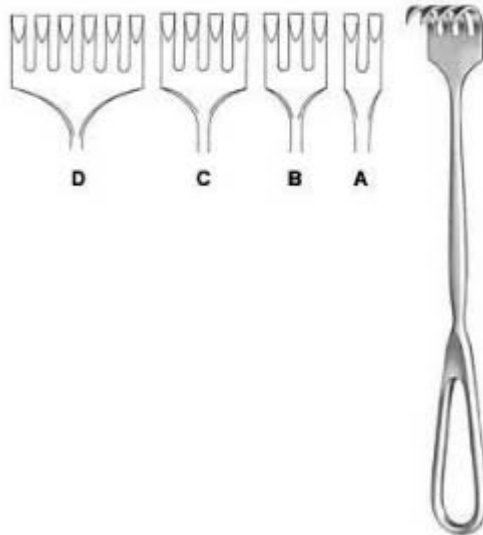

**SI-5-935-02**

**Martin**  
Retractor  
22.5 cm,



**SI-5-936-03**

**Ollier**  
Retractor  
23 cm 36 x 30, 23 cm 36 x 60,



**SI-5-937-02**

**Wassmund**

Retractor  
20.5 cm 33 x 21,

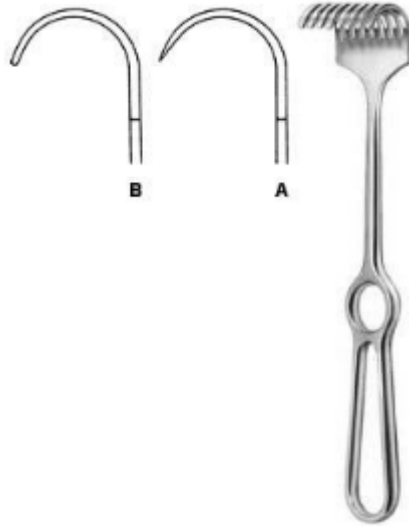

**SI-5-938-08**

**Korte**

Retractor  
24.5 cm 40 x 30,

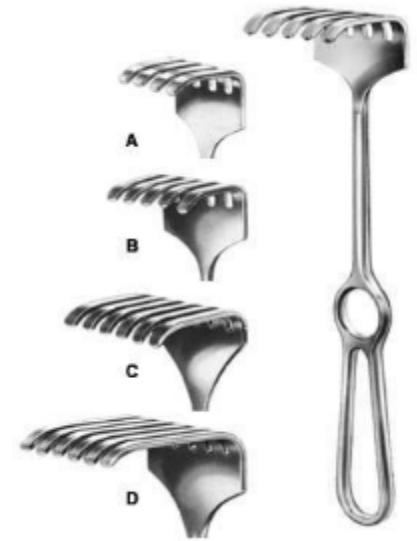

**SI-5-939-04**

**Israel**

Retractor  
25.5 cm,

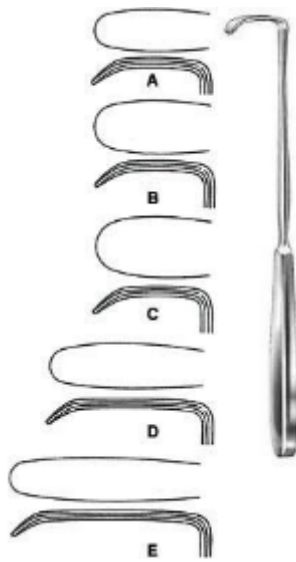

**SI-5-940-01**

**Langenbeck**

Retractor  
22.5 cm 30 x 11 mm, 22.5 cm 30 x 14 mm, 22.5 cm 30 x 16 mm, 22.5 cm 40 x 11 mm, 22.5 cm 50 x 11 mm,

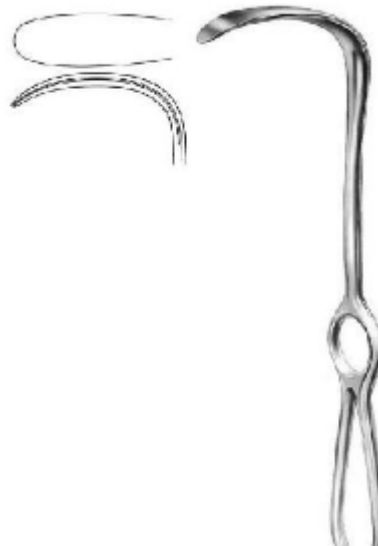

**SI-5-942-21**

**Langenbeck**

Retractor  
21 cm 65 x 20 mm,



**SI-5-943-21**

**Langenbeck**

Retractor  
22.5 cm 85 x 15 mm,



**SI-5-944-19**

**Lahey**

Retractor  
19.5 cm 36 x 19 mm,



**SI-5-945-20**

**Little**

Retractor  
20 cm 13 x 15 mm,



**SI-5-946-18**

**Kocher**

Retractor  
23 cm 43 x 18 mm, 23 cm 53 x 20 mm, 23 cm 63 x 25 mm, 23 cm 77 x 30 mm, 23 cm 78 x 40 mm,

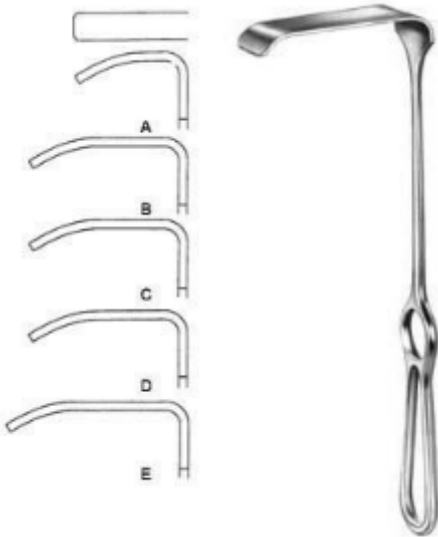

**SI-5-947-01**

**Kocher-Langenbeck**

Retractor  
21.5 cm 25 x 6 mm, 21.5 cm 35 x 8 mm, 21.5 cm 35 x 11 mm, 21.5 cm 35 x 15 mm, 21.5 cm 40 x 11 mm, 21.5 cm 55 x 11 mm, 21.5 cm 70 x 14 mm, 21.5 cm 80 x 12 mm,



**SI-5-948-01**

**Kocher-Langenbeck**

Retractor  
21.5 cm 25 x 10 mm, 21.5 cm 40 x 13 mm, 21.5 cm 60 x 13 mm, 21.5 cm 40 x 18 mm, 21.5 cm 60 x 18 mm, 21.5 cm 85 x 18 mm, 21.5 cm 60 x 25 mm, 21.5 cm 85 x 25 mm,

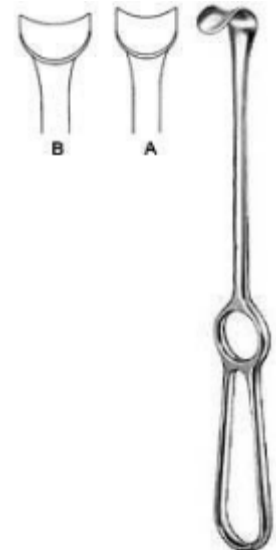

**SI-5-949-01**

**Kocher**

Retractor  
21.5 cm 22 x 12 mm, 21.5 cm 24 x 14 mm,

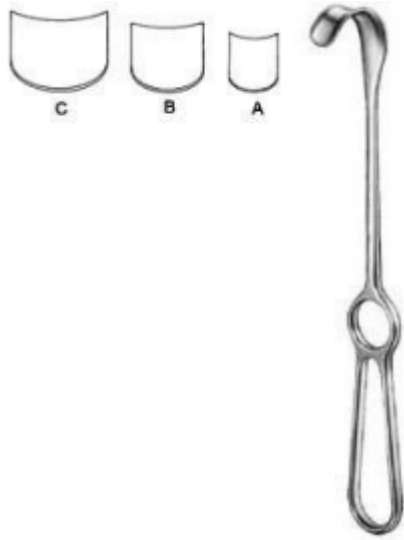

**SI-5-950-01**

**Kocher**

Retractor

22 cm 42 x 10 mm, 22 cm 42 x 15 mm, 22 cm 43 x 20 mm,

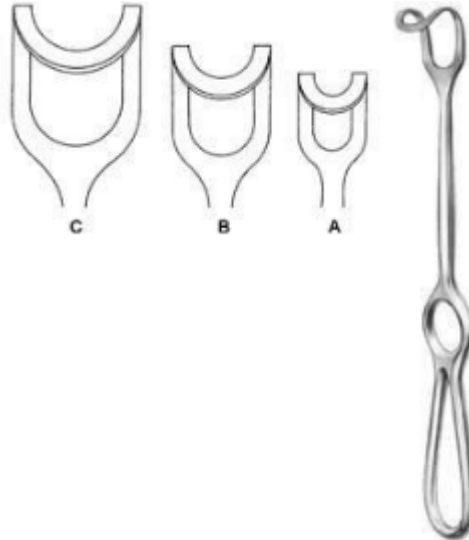

**SI-5-951-01**

**Middeldorpf**

Retractor

21.5 cm 18 x 17 mm, 23 cm 25 x 22 mm, 24.5 cm 30 x 31 mm,



**SI-5-952-01**

**Doyen-Stille**

Retractor

26 cm 97 x 29 mm, 26 cm 101 x 31 mm, 26 cm 127 x 52 mm,



**SI-5-953-01**

**Hosel**

Retractor

26 cm 63 x 21 mm, 26 cm 83 x 30 mm, 26 cm 103 x 30 mm, 26 cm 120 x 30 mm, 26 cm 140 x 30 mm, 26 cm 140 x 40 mm,



**SI-5-954-01**

**Middeldorpf**

Retractor

27 cm 48 x 45 mm, 27 cm 52 x 50 mm, 27 cm 60 x 70 mm,

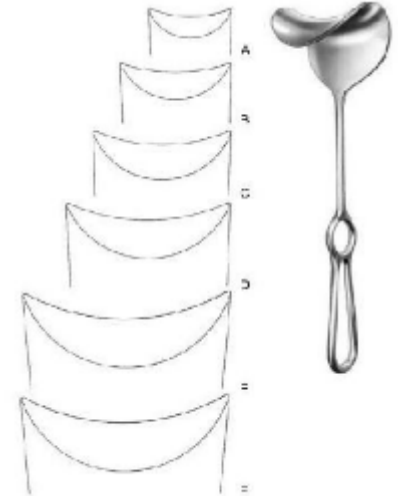

**SI-5-955-00**

**Fritsch**

Retractor

23.5 cm 37 x 31 mm, 24 cm 38 x 40 mm, 25 cm 43 x 51 mm, 25 cm 49 x 61 mm, 25.5 cm 48 x 75 mm, 25.5 cm 65 x 85 mm,



**SI-5-956-25**

**Doyen**

Retractor  
24 cm 48 x 88 mm,



**SI-5-957-22**

**Kocher**

Retractor  
24 cm 73 x 25 mm,



**SI-5-958-01**

**Kocher**

Retractor  
25 cm 80 x 45 mm, 25 cm 80 x 55 mm, 25 cm 80 x 65 mm,



**SI-5-959-25**

**Martin**

Retractor  
26 cm 110 x 27 mm,

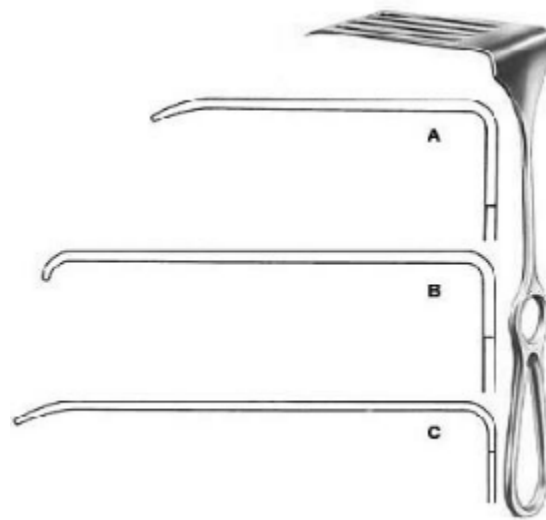

**SI-5-960-01**

**Coryllos**

Retractor  
24 cm 85 x 22 mm, 24 cm 108 x 43 mm, 24 cm 119 x 65 mm,



**SI-5-961-01**

**Davidson**

Retractor  
19 cm 80 x 54 mm, 18.5 cm 80 x 95 mm,





**SI-5-962-25**

**Sauerbruch**

Retractor  
25.5 cm 127 x 38 mm,

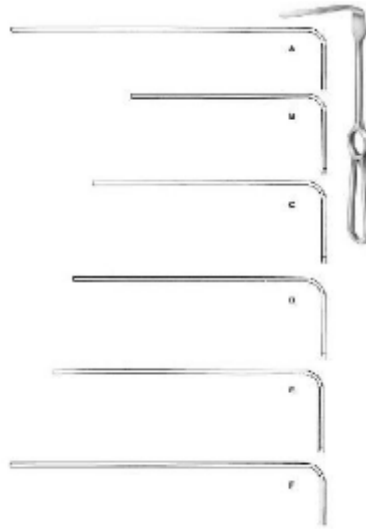

**SI-5-963-08**

**Brunner**

Retractor

25.5 cm 84 x 20 mm, 25.5 cm 104 x 25 mm, 25.5 cm 124 x 30 mm, 25.5 cm 130 x 30 mm, 25.5 cm 144 x 30 mm, 25.5 cm 160 x 30 mm, 25.5 cm 164 x 30 mm,

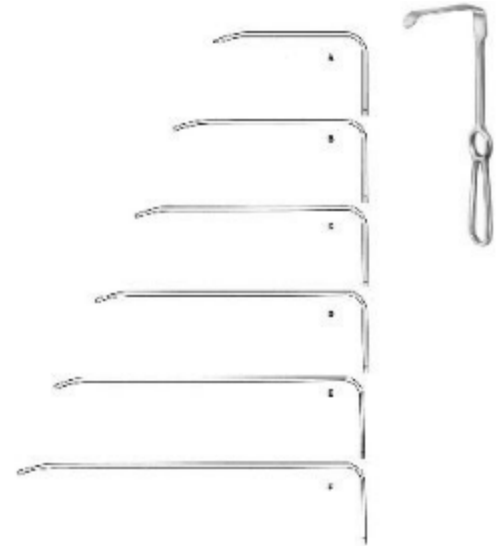

**SI-5-964-08**

**Brunner**

Retractor

25.5 cm 82 x 20 mm, 25.5 cm 102 x 20 mm, 25.5 cm 122 x 25 mm, 25.5 cm 140 x 25 mm, 25.5 cm 162 x 30 mm, 25.5 cm 182 x 30 mm,

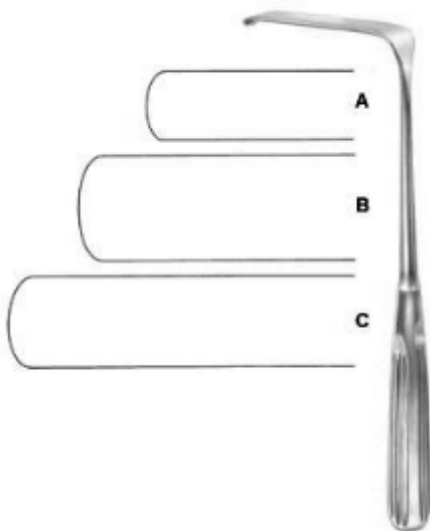

**SI-5-965-01**

**Sauerbruch**

Retractor

22.5 cm 50 x 15mm, 22.5 cm 63 x 23mm, 22.5 cm 80 x 20mm,



**SI-5-966-01**

**Deaver**

Retractor

18 cm 19mm,



**SI-5-968-01**

**Mikulicz**

Retractor

25 cm 90 x 35mm, 25 cm 125 x 50mm, 25 cm 160 x 50mm,



**SI-5-969-26**  
**Mikulicz**  
Retractor  
26 cm 90 x 55mm,

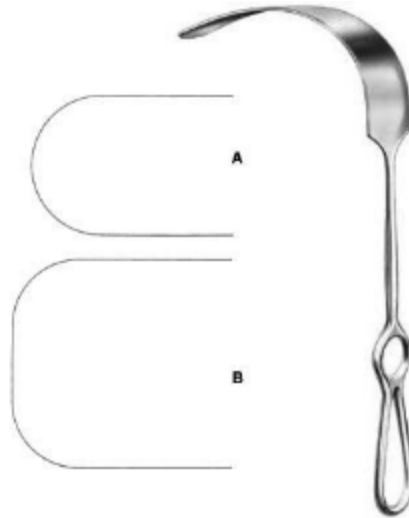

**SI-5-970-01**  
**Kelly**  
Retractor  
27.5 cm 205 x 38mm, 27.5 cm 205 x 57mm,



**SI-5-971-00**  
**Farabeuf**  
Retractor  
15 cm Fig. 1 = 23 x 16, 15 cm Fig. 1 = 26 x 16, 15 cm Fig. 2 = 27 x 16, 15 cm Fig. 2 = 30 x 16,

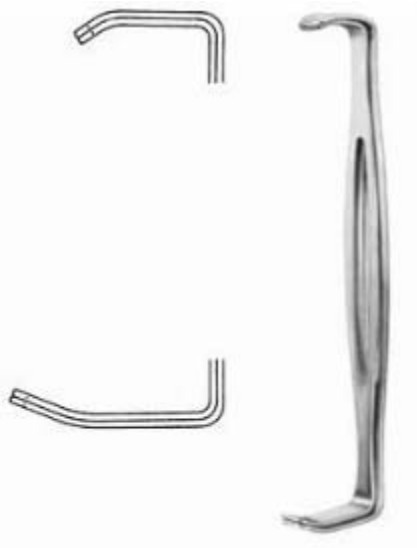

**SI-5-972-00**  
**Parker-Langenbeck**  
Retractor  
21.5 cm Fig. 1 = 21x15mm, 21.5 cm Fig. 1 = 40x15mm, 21.5 cm Fig. 2 = 25x15mm, 21.5 cm Fig. 2 = 45x15mm,



**SI-5-973-07**  
**Alm**  
Wound Spreaders, self-retaining  
7 cm,



**SI-5-974-07**  
**Alm**  
Wound Spreaders, self-retaining  
7 cm,



**SI-5-975-22**

**Gosset**

Abdominal Retractor  
18.5 cm,



**SI-5-976-00**

**Balfour-Baby**

Abdominal Retractor spreading 90mm, 1  
central blade 24 x 20mm  
12.5 cm,



**SI-5-977-00**

**Balfour**

Abdominal Retractor spreading 180mm,  
lateral blades 70 x 35mm, 1 central blade  
20 cm,



**SI-5-967-04**

**Deaver**

Retractor  
31.5 cm 25mm, 31.5 cm 38mm, 31.5 cm  
50mm, 31.5 cm 100mm,



**SI-5-1001-11**

Probe

11.5 cm, 13 cm, 14.5 cm, 16 cm, 18 cm, 20 cm, 25 cm, 30 cm,



**SI-5-1002-11**

Probe

11.5 cm, 13 cm, 14.5 cm, 16 cm, 18 cm, 20 cm, 25 cm, 30 cm,

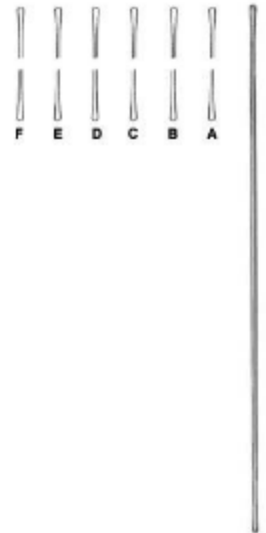

**SI-5-1003-13**

Probe

13 cm, 14.5 cm, 16 cm, 18 cm, 20 cm, 25 cm,



**SI-5-1004-13**

Probe with eye

13 cm, 14.5 cm, 16 cm,

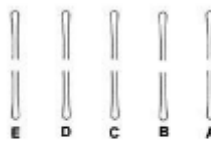

**SI-5-1006-13**

Myrtle Leaf Probe

13 cm, 14.5 cm, 16 cm, 18 cm, 20 cm,



**SI-5-1007-13**

Grooved Director

13 cm, 14 cm, 16 cm,



**SI-5-1008-13**

Grooved Director  
13 cm, 14.5 cm, 16 cm,



**SI-5-1009-14**

**Doyen**  
Grooved Director  
14.5 cm,



**SI-5-1010-16**

**Nelaton**  
Grooved Director  
16 cm,

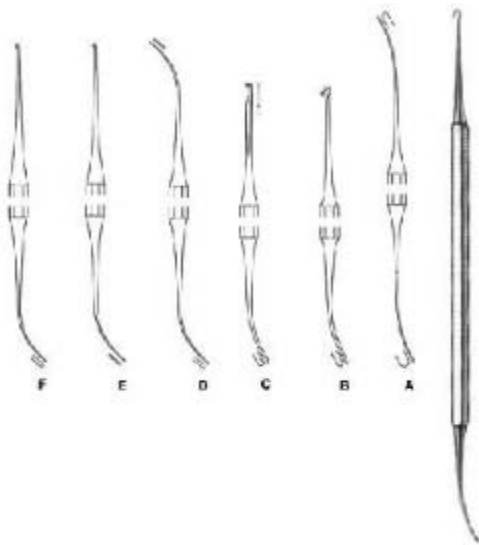

**SI-5-1011-01**

**Varady**  
Phlebodissector  
18 cm, 17.5 cm,

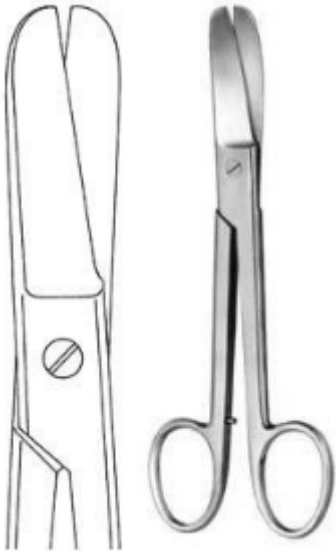

**SI-6-101-23**

**Lorenz**

Bandage Scissors heavy pattern  
23 cm,



**SI-6-102-14**

**Lister**

Bandage Scissors  
14.5 cm, 18.5 cm, 20 cm,



**SI-6-103-23**

**Bergmann**

Plaster Shears  
23.5 cm,



**SI-6-104-20**

**Esmarch**

Plaster Shears heavy pattern, short  
blades  
20 cm,



**SI-6-105-15**

Bandage Scissors black plastic ring with  
autodavable  
16 cm, 19 cm,



**SI-6-106-18**

Bandage Scissors black plastic rings  
19 cm, 16 cm,

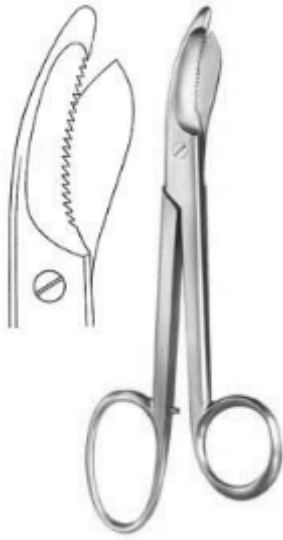

**SI-6-107-24**

**Bruns**

Plaster Scissors  
24 cm,



**SI-6-108-23**

**Stille-Martin**

Plaster Shears  
23 cm, 27 cm, 38 cm,

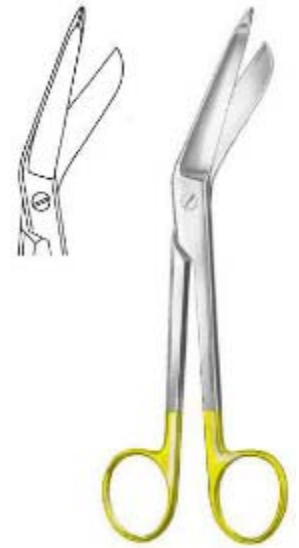

**SI-6-109-18**

**Lister**

Bandage Scissors  
18 cm,



**SI-6-110-24**

**Bruns**

Plaster Scissors  
24 cm,



**SI-6-111-20**

**Hopkins**

Plaster Knife with wooden handle  
20 cm,



**SI-6-112-18**

**Reiner**

Plaster Knife  
18 cm,



**SI-6-113-18**

**Reiner**

Plaster Knife  
18 cm,



**SI-6-114-21**

**Martin**

Plaster Knife with wooden handle  
21 cm,



**SI-6-115-14**

**Engel**

Plaster Saw  
15.5 cm,

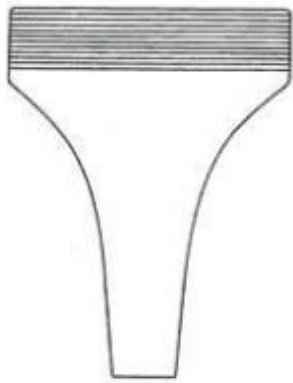

**SI-6-116-28**

**Hennig**

Plaster Spreader  
28 cm,



**SI-6-117-18**

**Wolff**

Plaster Breaker  
18 cm, 26.5 cm,

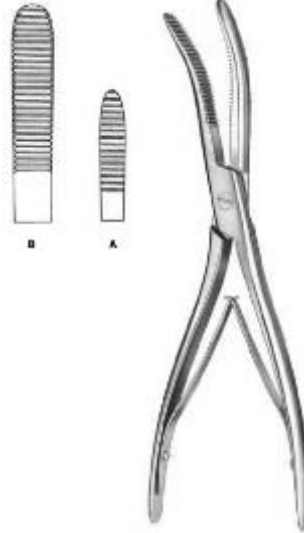





**SI-8-101-01**

**Gigli**

Wire Saw Handle



**SI-8-102-33**

**De Martel**

Wire Saw Guide  
33 cm,



**SI-8-103-01**

**Crutchfield**

Skull Traction Tong small pattern



**SI-8-104-01**

Skull Traction Tong large pattern  
22.5 cm,



**SI-8-105-20**

**Dahlgren**

Cranial Rongeur  
20 cm,



**SI-8-106-14**

**Olivecrona-Toennis**

Clip Applying Forceps



**SI-8-107-19**

**McKenzie**

Clip Applying Forceps  
18.5 cm,



**SI-8-108-18**

**Olivecrona**

Dura Dissector  
18 cm,



**SI-8-109-19**

**Olivecrona**

Dura Dissector  
20 cm,



**SI-8-110-21**

**Milligan**

Dura Dissector  
21.5 cm,



**SI-8-111-21**

**Davis**

Dura Dissector sharp  
21.5 cm,



**SI-8-112-22**

Dura Dissector  
22 cm,



**SI-8-113-24**

**Davis**

Dura Dissector  
24.5 cm,



**SI-8-114-19**

**Love**

Nerve Root Retractor  
21.5 cm, 18 cm, 11 cm,



**SI-8-115-18**

**Olivecrona**

Brain Spatula  
18 cm,



**SI-8-116-23**

**Scoville**

Nerve Root Retractor 8mm  
23.5 cm,



**SI-8-117-24**

**Holsher**

Nerve Root Retractor 8mm  
23.5 cm,

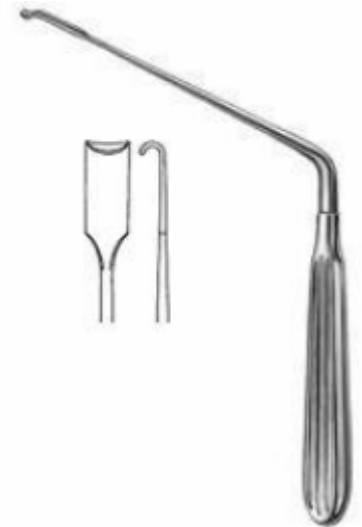

**SI-8-118-19**

**Scoville**

Nerve Root Retractor 7mm  
16.5 cm,



**SI-8-119-26**  
**Groningen**  
Nerve Hook  
26.5 cm,



**SI-8-120-26**  
**Groningen**  
Nerve Hook  
26.5 cm,



**SI-8-121-19**  
**Cushing**  
Nerve Hook blunt  
19 cm,28 cm,

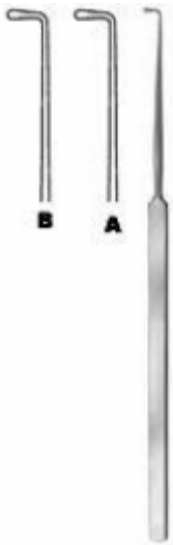

**SI-8-122-19**  
**Cushing**  
Nerve Hook  
19.5 cm,28 cm,



**SI-8-123-17**  
**Smithwick**  
Nerve Hook  
17 cm,21 cm,



**SI-8-125-20**  
**Halle**  
Dura Knife  
20 cm,



**SI-8-126-20**

**Adson**

Dura Hook  
20 cm,



**SI-8-127-16**

**Graham**

Dura Hook blunt  
16.5 cm,



**SI-8-128-18**

**Sachs**

Dura Hook sharp  
18 cm,



**SI-8-129-15**

**Toennis**

Dura Hook sharp  
14.5 cm,



**SI-8-130-13**

**Frazier**

Dura Hook sharp  
13 cm, 18 cm,



**SI-8-131-01**

**Krayenbuhl**

Nerve and Vessel Hooklet  
18.5 cm Fig. 1, 18.5 cm Fig. 2,



**SI-8-132-16**

**Cloward**

Lamina Spreader  
16 cm,

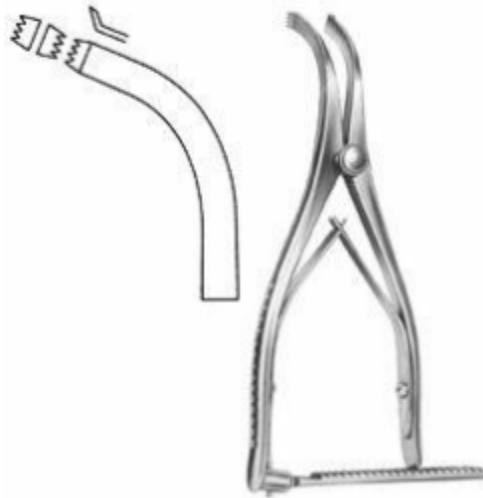

**SI-8-133-17**

**Inge**

Lamina Spreader  
16 cm,

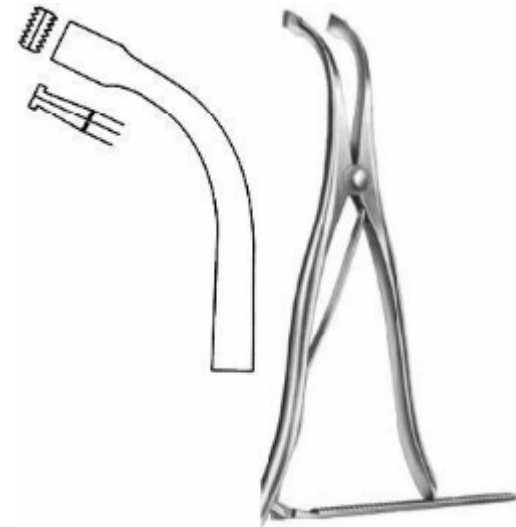

**SI-8-134-27**

**Inge**

Lamina Spreader  
25.5 cm,

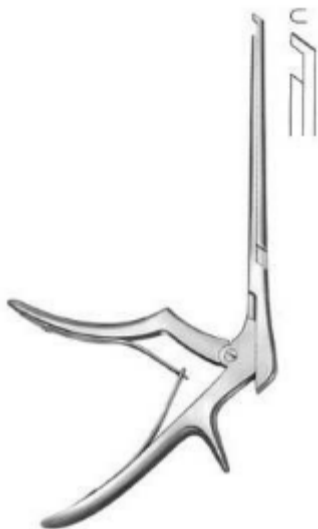

**SI-8-135-03**

**Ferris-Smith Kerrison**

Laminectomy Punch 3mm downwards  
cutting 40 degree shaft length 180 mm



**SI-8-138-01**

**Ferris-Smith Kerrison**

Laminectomy Punch upwards cutting shaft  
length 180 mm  
1 mm, 2 mm, 3 mm, 4 mm, 5 mm, 6 mm,

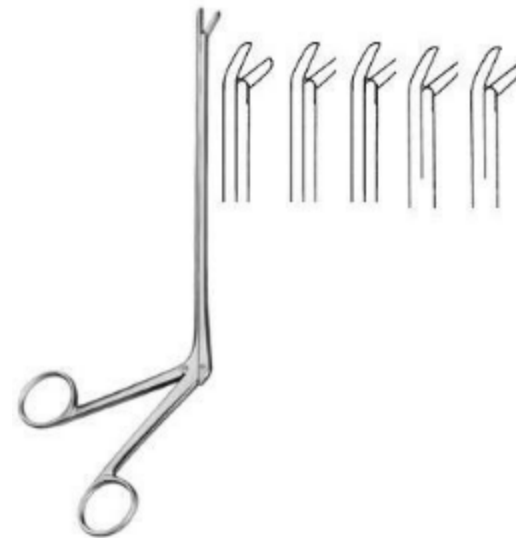

**SI-8-139-01**

**Cushing**

Laminectomy Rongeur jaw 2 x 10 to 4 x 10 mm  
straight shaft length 180 mm

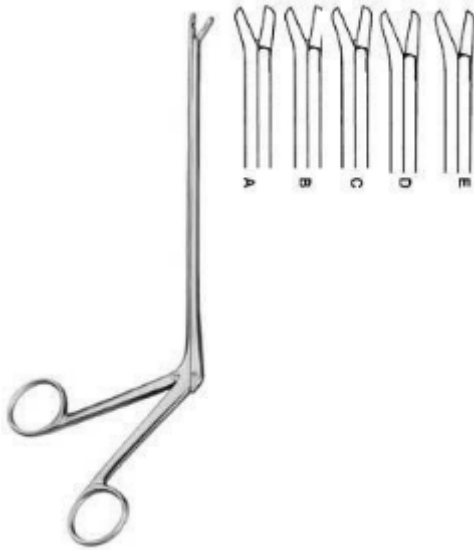

**SI-8-140-01**

**Cushing**

Laminectomy Rongeur jaw 2 x 10 to 4 x 10 mm upwards 45 degree shaft length 120 mm



**SI-8-137-01**

**Ferris-Smith Kerrison**

Laminectomy Punch  
1 mm, 2 mm, 3 mm, 4 mm, 5 mm, 6 mm,



**SI-9-101-23**

Bone Shear  
23 cm,



**SI-9-102-22**

Rib Shear  
23 cm,



**SI-9-103-22**

**Gluck**  
Rib Shears  
21 cm,



**SI-9-104-27**

**Giertz-Stille**  
Rib Shear  
24.5 cm,



**SI-9-105-24**

**Lebsche**  
Sternum Chisel  
24.5 cm,



**SI-9-106-01**

Rib Retractor lateral blades 12 x 16 mm  
spreading 95 mm  
Size 1,





**SI-9-107-01**

**Finochietto, Infant**

Rib Retractor lateral blades 15 x 15 mm  
spreading 75 mm

Size 1,



**SI-9-108-01**

**Finochietto, Baby**

Rib Retractor lateral blades 31 x 31 mm  
spreading 100 mm

Size 1,



**SI-9-109-01**

**Finochietto**

Rib Retractor lateral blades 40 x 45 mm  
spreading 135 mm

Size 1,



**SI-9-110-01**

**Burford**

Rib Retractor with two pairs of blades 47 x  
62 mm + 65 x 62 mm, spreading 200 mm

Size 1,



**SI-9-111-01**

**Castaneda**

Rib Retractor lateral blades 10,5 x 32 mm  
spreading 65 mm

Size 1,



**SI-9-112-01**

**Finochietto (modif.)**

Rib Retractor lateral blades 14 x 15 mm spreading  
120 mm

Size 1,



**SI-9-113-90**

**Haight**

Rib Retractor lateral blades 30 x 30 mm spreading 120 mm  
Size 1,



**SI-9-114-01**

**Morse-Favaloro**

Sternal Retractor 4 movable blades 17 x 22 mm spreading 160 mm Sternal Retractor  
Size 1,



**SI-9-115-00**

**Morse**

Sternal Retractor 4 movable blades 22 x 27 mm spreading 200 mm  
Size 1,



**SI-9-116-02**

**Tuffier**

Rib Retractor lateral blades 22 x 27 mm spreading 200 mm  
Size 1,

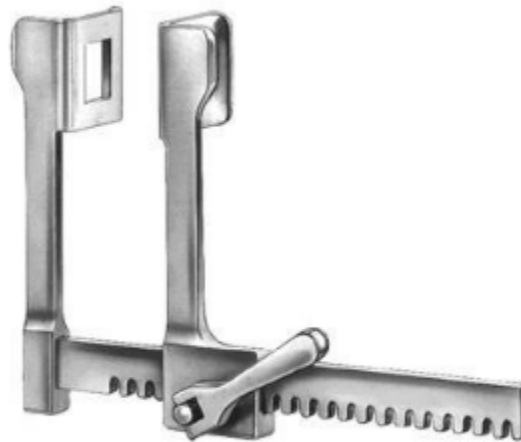

**SI-9-117-75**

**Finochietto, Baby**

Rib Retractor lateral blades 14 x 15 mm spreading 75 mm  
Size 1,



**SI-9-118-01**

**Finochietto**

Rib Retractor lateral blades 30 x 45 mm spreading 150 mm  
Size 1,



**SI-9-119-00**

**DeBakey**

Rib Retractor spreading 150 mm  
Size 1,



**SI-9-120-00**

**DeBakey**

Rib Retractor spreading 200 mm  
Size 1,



**SI-9-121-00**

Thoracic Retractor  
Size 1,



**SI-9-122-19**

**Sellors**

Rib Contractor  
20 cm,



**SI-9-123-14**

**Bailey-Baby**

Rib Contractor  
15.5 cm,



**SI-9-124-16**

**Bailey**

Rib Contractor  
20 cm,



**SI-9-125-16**  
**Bailey-Gibbon**  
 Rib Contractor  
 20 cm,



**SI-9-126-30**  
**Allison**  
 Lung Spatula  
 29.5 cm, 32.5 cm,



**SI-9-127-22**  
**Price-Thomas**  
 Bronchus Clamp  
 22 cm,



**SI-9-128-22**  
**Price-Thomas**  
 Bronchus Clamp  
 22 cm,

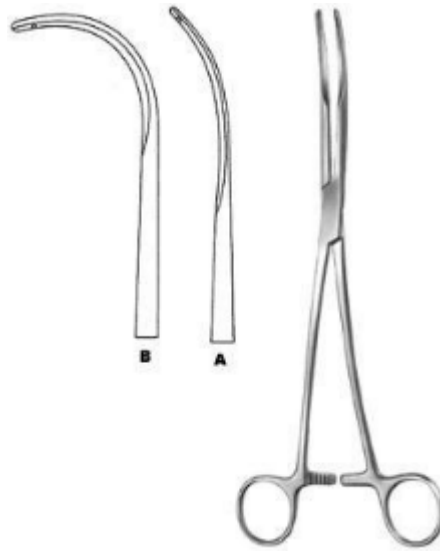

**SI-9-129-24**  
**Semb**  
 Bronchus Clamp  
 24.5 cm,

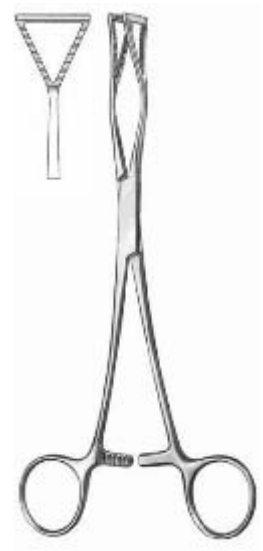

**SI-9-130-20**  
**Lovelace**  
 Lung Grasping Forceps  
 20.5 cm,



**SI-9-131-20**

**Lovelace**

Lung Grasping Forceps  
19 cm,



**SI-9-132-07**

**DeBakey-Satinsky**

Bulldog Clamp  
7 cm, 9 cm,



**SI-9-133-06**

**Glover**

Bulldog Clamp  
6 cm,



**SI-9-134-07**

**Santulli**

Bulldog Clamp  
7 cm,



**SI-9-135-09**

**Gregory, soft**

Bulldog Clamp  
9 cm, 11 cm,



**SI-9-136-01**

**Gregory**

Bulldog Clamp  
10.5 cm,

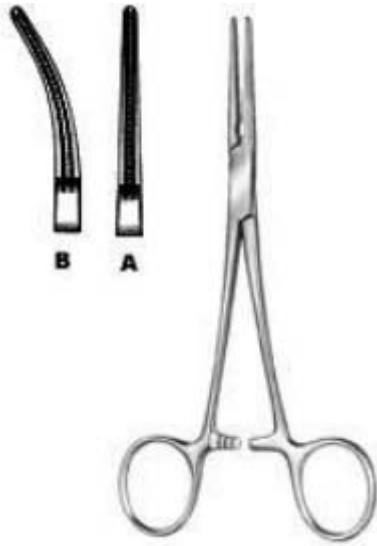

**SI-9-137-16**

**DeBakey-Rankin**

Haemostatic Forceps  
16 cm,



**SI-9-138-15**

**DeBakey-Mosquito**

Haemostatic Forceps  
15 cm,



**SI-9-139-23**

**Ochsner**

Aortic Clamp  
23.5 cm,



**SI-9-140-21**

**Diethrich**

Aortic Clamp  
22 cm,



**SI-9-141-00**

**Dardik**

Multi purpose Vascular Clamp  
15 cm,



**SI-9-142-18**

**Dale**

Peripheral Vascular Clamp  
18 cm,

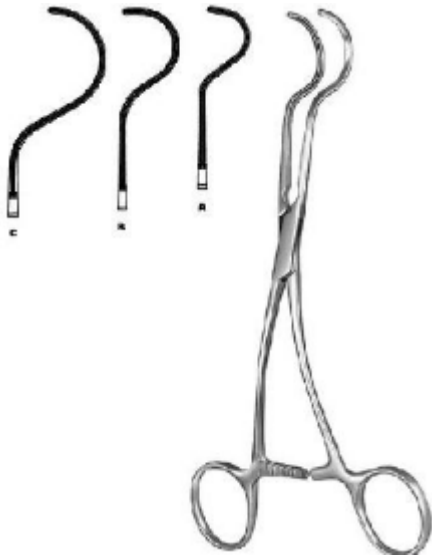

**SI-9-143-17**

**Dale**

Peripheral Vascular Clamp  
17.5 cm,

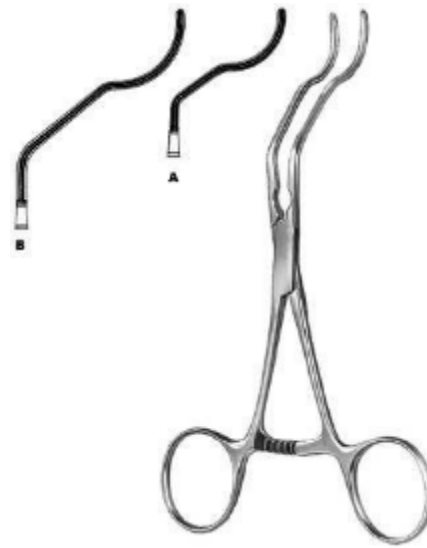

**SI-9-144-14**

**Gregory**

Profunda Clamp  
13 cm, 16 cm, 18 cm,

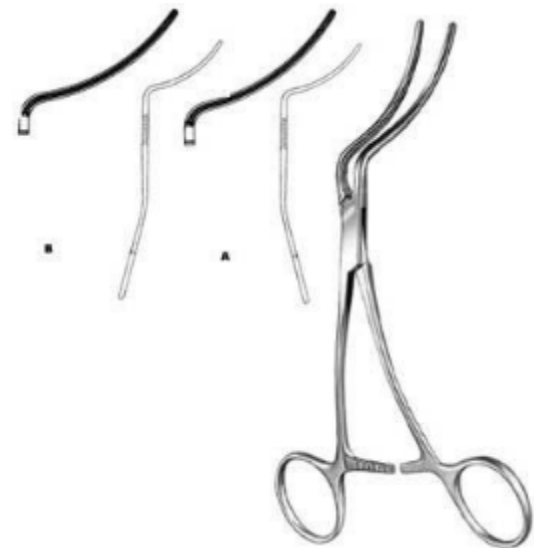

**SI-9-145-16**

**Martin**

Peripheral Vascular Clamp  
16.5 cm,



**SI-9-146-18**

**Husfeldt**

Peripheral Vascular Clamp  
17.5 cm,



**SI-9-147-18**

**Husfeldt**

Peripheral Vascular Clamp  
18 cm,



**SI-9-148-17**

**Husfeldt**

Peripheral Vascular Clamp  
17 cm,



**SI-9-149-16**

**DeBakey**

Vascular Forceps  
16 cm,



**SI-9-150-16**

**DeBakey**

Vascular Forceps  
16 cm,



**SI-9-151-16**

**DeBakey**

Vascular Forceps  
16 cm,



**SI-9-152-16**

**DeBakey**

Vascular Forceps  
16 cm,



**SI-9-153-16**

**DeBakey**

Vascular Forceps  
16 cm,



**SI-9-154-07**

**DeBakey**

Bulldog Clamp  
7.5 cm,





**SI-9-155-07**

**DeBakey**

Bulldog Clamp  
7.5 cm,



**SI-9-156-23**

Applying Forceps  
23.5 cm,



**SI-9-157-06**

**Glover**

Bulldog Clamp  
7 cm,



**SI-9-158-06**

**Glover**

Bulldog Clamp  
6.5 cm,

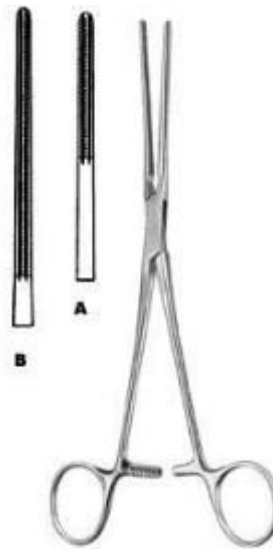

**SI-9-159-21**

**Potts**

Coarctation Clamp  
21 cm,

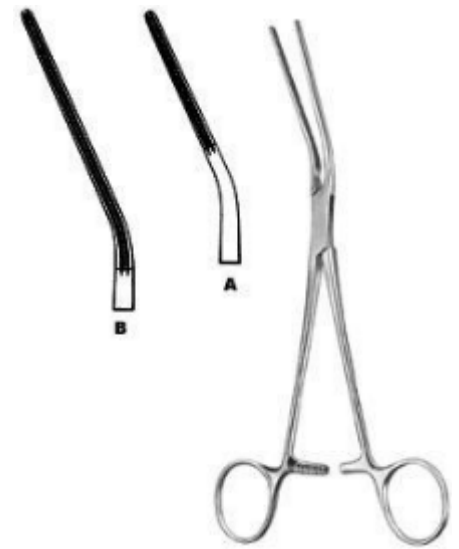

**SI-9-160-21**

**Potts**

Coarctation Clamp  
20.5 cm,

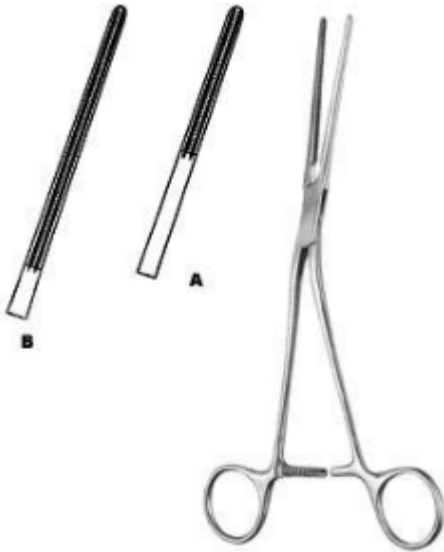

**SI-9-161-21**

**Potts**

Coarctation Clamp  
20.5 cm,



**SI-9-162-22**

**Potts**

Anastomosis Clamp  
21.5 cm,



**SI-9-163-22**

**Potts**

Anastomosis Clamp  
22 cm,



**SI-9-164-19**

**DeBakey**

Ligature Forceps  
19 cm,



**SI-9-165-16**

**DeBakey**

Peripheral Vascular Clamp  
16 cm,



**SI-9-166-19**

**DeBakey**

Peripheral Vascular Clamp  
16 cm,



**SI-9-167-18**

**Leland-Jones**

Peripheral Vascular Clamp  
18 cm,



**SI-9-168-15**

**Bainbridge**

Multi purpose Vascular Clamp  
15 cm,



**SI-9-169-15**

**Bainbridge**

Multi purpose Vascular Clamp  
15 cm,

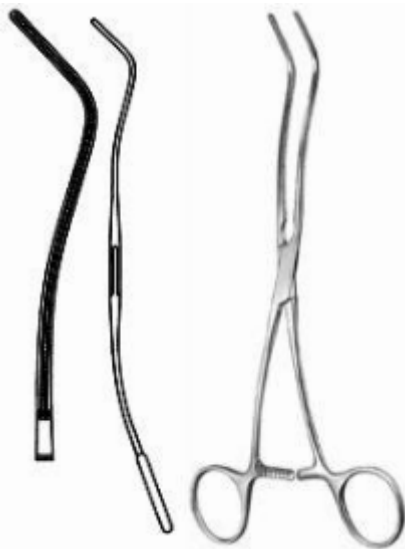

**SI-9-170-20**

**DeBakey**

Multi purpose Vascular Clamp  
20 cm,



**SI-9-171-26**

**DeBakey**

Aortic Aneurysm Clamp  
26 cm,



**SI-9-172-28**

**DeBakey**

Aortic Aneurysm Clamp  
28 cm,



**SI-9-173-30**

**DeBakey**

Aortic Aneurysm Clamp  
30 cm,



**SI-9-174-27**

**DeBakey**

Aortic Clamp  
27 cm,



**SI-9-175-24**

**DeBakey**

Ligature Forceps  
24.5 cm,



**SI-9-176-24**

**DeBakey**

Ligature Forceps  
24.5 cm,



**SI-9-178-25**

**DeBakey**

Ligature Forceps  
27 cm,

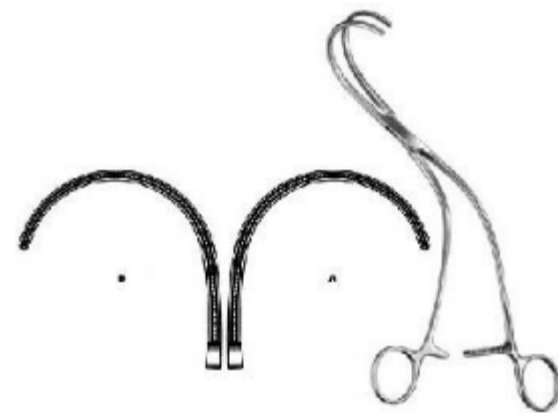

**SI-9-179-01**

**Weber**

Aortic Clamp  
24 cm,



**SI-9-180-20**

**Satinsky**

Tangential Occlusion Clamp  
22 cm,



**SI-9-181-01**

**Harken**

Auricle Clamp  
24.5 cm,



**SI-9-182-23**

**Lees**

Bronchus Clamp  
23 cm,



**SI-9-183-25**

**Lees**

Bronchus Clamp  
25 cm,



**SI-9-184-21**

**Lambert-Kay**

Anastomosis Clamp  
22.5 cm,



**SI-9-185-17**

**DeBakey**

Anastomosis Clamp  
16.5 cm,



**SI-9-186-18**  
**Morris-DeBakey**  
Aortic Clamp  
16.5 cm,



**SI-9-187-23**  
**DeBakey-Bahnson**  
Aneurysm Clamp  
23.5 cm,

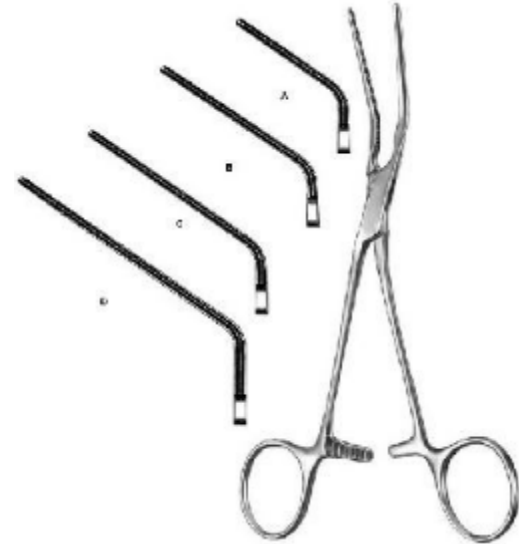

**SI-9-188-20**  
**DeBakey**  
Multi purpose Vascular Clamp  
18 cm,



**SI-9-189-12**  
**DeBakey-Mosquito**  
Haemostatic Forceps  
12.5 cm,



**SI-9-190-12**  
**DeBakey-Mosquito**  
Haemostatic Forceps  
12.5 cm,



**SI-9-191-17**  
**DeBakey**  
Multi purpose Vascular Clamp  
17 cm,



**SI-9-192-16**

**DeBakey**

Multi purpose Vascular Clamp  
16.5 cm,

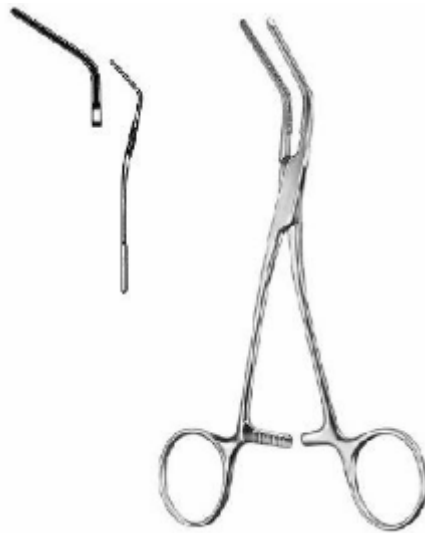

**SI-9-193-15**

**DeBakey**

Multi purpose Vascular Clamp  
16 cm,

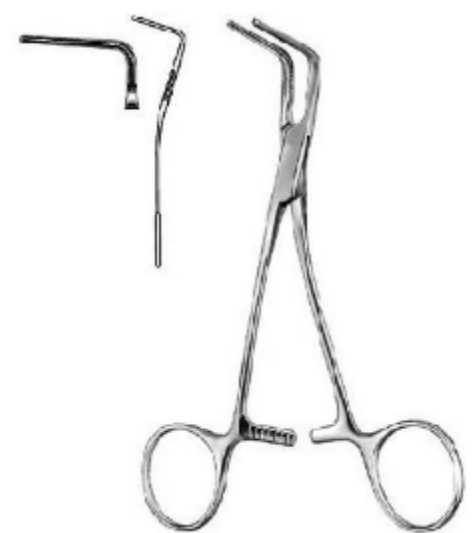

**SI-9-194-15**

**DeBakey**

Multi purpose Vascular Clamp  
16.5 cm,



**SI-9-195-17**

**DeBakey**

Multi purpose Vascular Clamp  
16.5 cm,



**SI-9-196-17**

**Glover**

Multi purpose Vascular Clamp  
17 cm,



**SI-9-197-17**

**Glover**

Multi purpose Vascular Clamp  
17.5 cm,



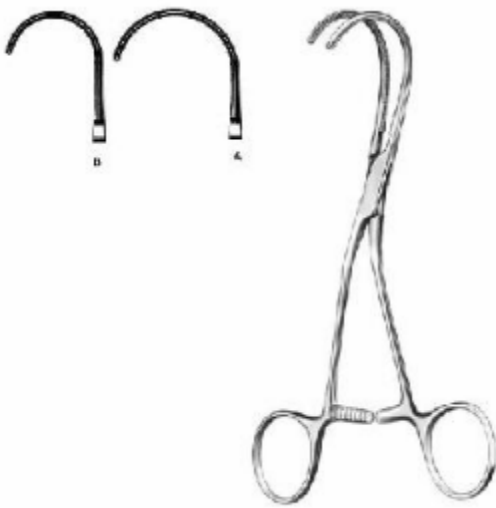

**SI-9-198-16**

**DeBakey**

Multi purpose Vascular Clamp  
16.5 cm,

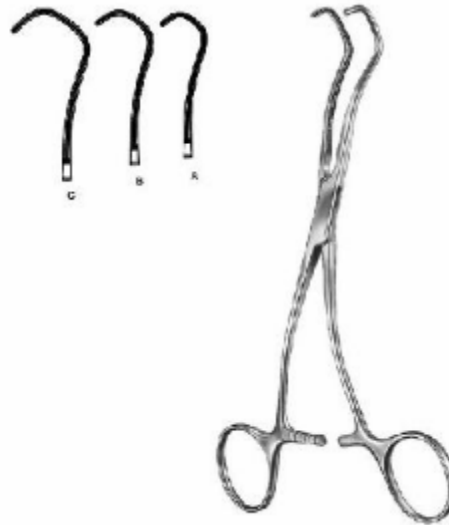

**SI-9-199-16**

**Derra**

Anastomosis Clamp  
16.5 cm Fig. 1, 17 cm Fig. 2, 18 cm Fig. 3,



**SI-9-200-17**

**DeBakey-Beck**

Anastomosis Clamp  
17 cm,



**SI-9-201-16**

**Cooley**

Vascular Forceps  
16 cm,

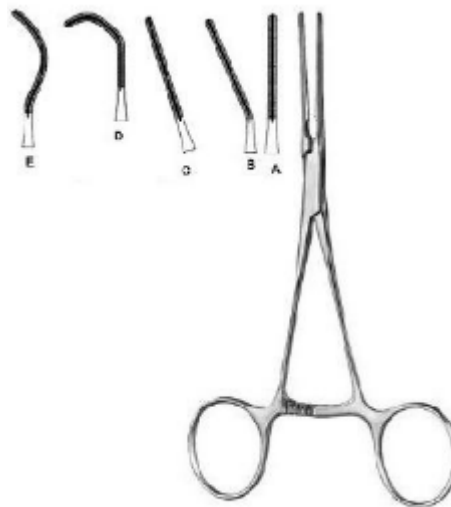

**SI-9-202-01**

**Cooley**

Pediatric Vascular Clamp  
14.5 cm,



**SI-9-203-21**

**Cooley**

Iliac Clamp  
22 cm,





**SI-9-204-17**

**Cooley**

Anastomosis Clamp  
17 cm,

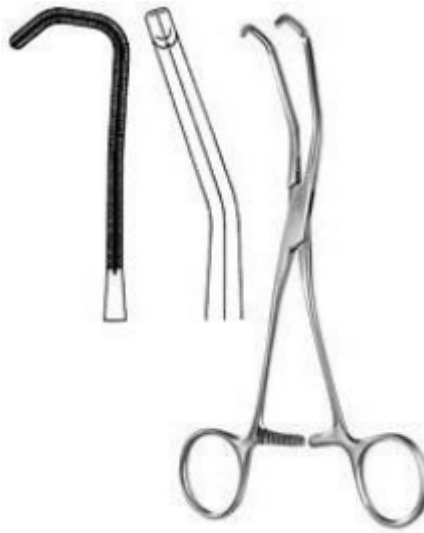

**SI-9-205-17**

**Cooley**

Anastomosis Clamp  
20 cm,



**SI-9-206-16**

**Cooley**

Anastomosis Clamp  
17 cm,



**SI-9-207-15**

**Cooley**

Multi purpose Vascular Clamp  
16 cm,



**SI-9-208-17**

**Cooley**

Multi purpose Vascular Clamp  
17 cm,



**SI-9-209-17**

**Cooley**

Multi purpose Vascular Clamp  
17 cm,



**SI-9-210-17**

**Cooley**

Multi purpose Vascular Clamp  
17.5 cm,



**SI-9-211-16**

**Cooley**

Multi purpose Vascular Clamp  
16.5 cm,



**SI-9-212-16**

**Cooley-Derra**

Anastomosis Clamp  
16.5 cm,



**SI-9-213-17**

**Cooley-Beck**

Anastomosis Clamp  
17 cm,

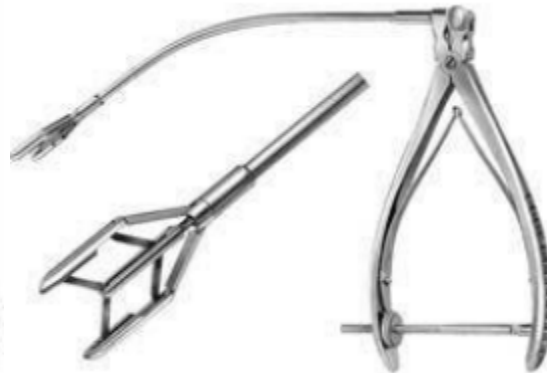

**SI-9-214-00**

**Cooley**

Aortic Dilator



**SI-9-215-05**

**Cooley**

Vascular Dilator  
13 cm 0,5 mm ?,



**SI-9-216-05**

**DeBakey**

Vascular Dilator  
19 cm 0,5 mm ?,



**SI-9-217-00**

**Martin**

Tunneling Set complete set with three shafts, two handles and 12 tips in storage case.



**SI-9-218-01**

**Hach**

Fasciotomy Knife with plastic handle  
30 cm,



**SI-9-219-18**

Intima Spatula  
18.5 cm,

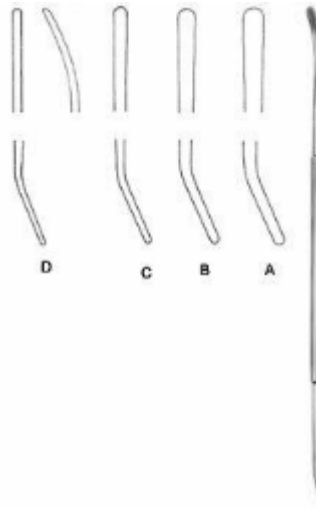

**SI-9-220-01**

**Robb**

Vascular Dissector  
24 cm Fig. 1 2,5 mm ?, 24 cm Fig. 2 2,0 mm ?,



**SI-9-221-20**

**Crile**

Nerve Hooklet  
20 cm,

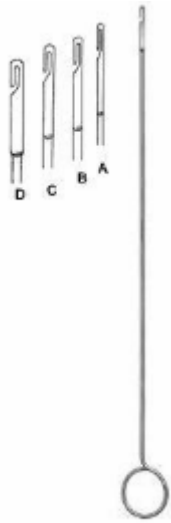

**SI-9-222-15**

Ligature Catcher  
26 cm 1,5 mm,



**SI-9-223-15**

**Subramanian-Miniature**  
Aortic Clamp 135 degree  
15.5 cm,

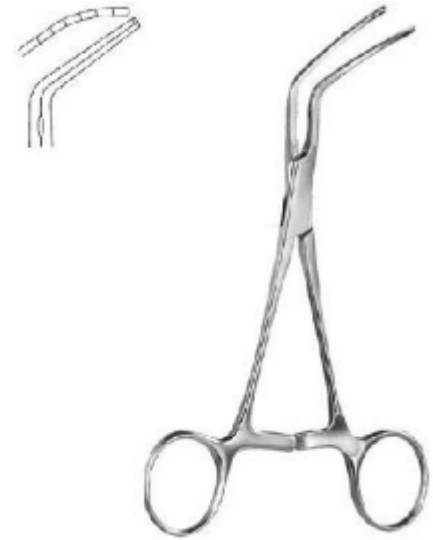

**SI-9-224-16**

**Subramanian**  
Aortic Clamp  
16 cm,

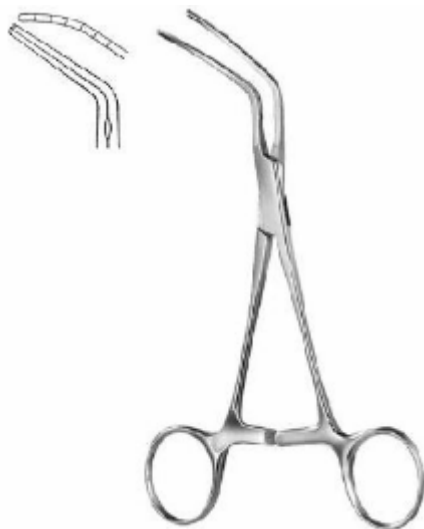

**SI-9-225-16**

**Subramanian**

Aortic Clamp  
13.5 cm Fig. 1, 13.5 cm Fig. 2, 14 cm Fig. 3,

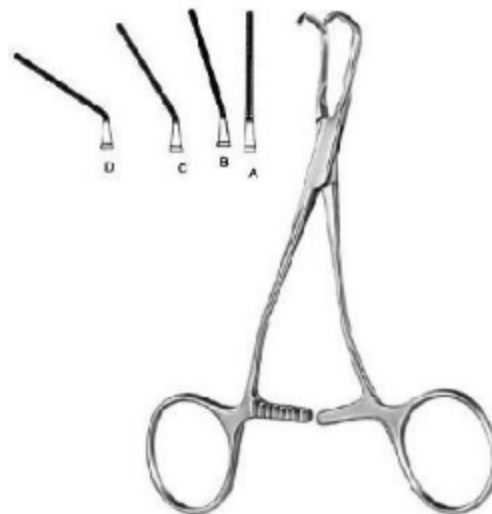

**SI-9-226-01**

**Pediatric Vascular Clamp**



**SI-9-227-16**

**Pediatric Vascular Clamp**  
16.5 cm,



**SI-9-228-16**

Pediatric Vascular Clamp  
16 cm,



SI-11-101-03

**Barraquer (Colibri)**

Barraquer  
Size 1,



SI-11-102-07

Bowman  
Size 1,



SI-11-103-06

Critchett  
Size 1,



SI-11-104-05

Smith  
Size 1,



SI-11-105-08

Clark  
Size 1,



SI-11-106-06

Graefe  
Size 1,



**SI-11-107-08**

Week  
Size 1,



**SI-11-108-07**

Arruga  
Size 1,



**SI-11-109-07**

Arruga  
Size 1,



**SI-11-110-05**

Murdock  
Size 1,



**SI-11-111-07**

**Millenger**  
Mellinger Axenfeld  
Size 1,



**SI-11-112-07**

**Millenger**  
Mellinger Axenfeld  
Size 1,



SI-11-113-07

**Millenger**

Millenger  
Size 1,



SI-11-114-08

**Lister Burch**  
Size 1,



SI-11-115-08

**Williams Eye Speculum**

Williams  
7 cm, 8.3 cm,



SI-11-116-07

**Lancaster**

Lancaster  
Size 1,



SI-11-118-08

**Ziegler**  
Size 1,



SI-11-120-07

**Mueller**

Mueller  
Size 1,





**SI-11-121-11**  
**Jaeger Lid Plate**  
Jaeger  
4", 20mm, 23mm,



**SI-11-122-03**  
**VON GRAEFE Knife**  
Graefe  
1, 2, 3, 4, 5,



**SI-11-123-01**  
**Jaeger**  
Size 1,



**SI-11-124-13**  
**Berens**  
Size 1,

**SI-11-126-01**  
**ZIEGLER knife Needle**  
Ziegler  
11.4 cm,



**SI-11-127-12**  
**Castroviejo Cyclo-dialysis Spatula**  
Castroviejo  
13.3 cm,



**SI-11-128-12**

Wheeler  
Size 1,



**SI-11-129-05**

**Castroviejo Cyclodialysis Spatula**

Castroviejo  
Size 1,



**SI-11-130-12**

Dix  
Size 1,



**SI-11-131-13**

Dix  
Size 1,



**SI-11-132-13**

Dix  
Size 1,



**SI-11-133-07**

**Castroviejo Caliper**

Castroviejo  
8.3 cm,



**SI-11-134-13**

Connin Amsler  
Size 1,



**SI-11-135-06**

Dastoor  
Size 1,



**SI-11-136-09**

Holth  
Size 1,



**SI-11-137-03**

**Wilder Lacrimal Dilator**

Wilder  
10.2 cm,



**SI-11-138-12**

**ZIEGLER Lacrimal Dilator**

Ziegler  
14 cm Double End,



**SI-11-139-12**

**Castroviejo Lacrimal Dilator**

Castroviejo  
14 cm,



**SI-11-140-78**

Bowman  
Size 1,



**SI-11-141-07**

Graefe  
Size 1,



**SI-11-142-07**

Graefe  
Size 1,



**SI-11-143-07**

Graefe  
Size 1,



**SI-11-144-07**

Graefe  
Size 1,



**SI-11-145-07**

Fischer  
Size 1,



SI-11-146-07

Barraquer Katzin  
Size 1,



SI-11-147-07

Troutman  
Size 1,



SI-11-148-07

Barraquer  
Size 1,



SI-11-149-07

Barraquer  
Size 1,



SI-11-150-09

McCullough  
Size 1,



SI-11-151-09

McCullough  
Size 1,



**SI-11-152-10**

Jameson  
Size 1,



**SI-11-153-10**

Jameson  
Size 1,



**SI-11-154-10**

Bonaccolto  
Size 1,



**SI-11-155-10**

Bonaccolto  
Size 1,



**SI-11-156-10**

Dastoor  
Size 1,



**SI-11-157-10**

Dastoor  
Size 1,



**SI-11-158-05**

Bishop Harman  
Size 1,



**SI-11-159-08**

Bishop Harman  
Size 1,



**SI-11-160-05**

Bishop Harman  
Size 1,



**SI-11-161-08**

Bishop Harman  
Size 1,



**SI-11-162-07**

Mod Bonn  
Size 1,



**SI-11-163-07**

Mod Bonn  
Size 1,



**SI-11-164-10**

Mod Bonn  
Size 1,



**SI-11-165-10**

Mod Bonn  
Size 1,



**SI-11-166-10**

Mod Bonn  
Size 1,



**SI-11-167-10**

Mod Bonn  
Size 1,



**SI-11-168-10**

Prince  
Size 1,



**SI-11-169-10**

Prince  
Size 1,





SI-11-170-20

Berke  
Size 1,



SI-11-171-08

Troutman  
Size 1,



SI-11-172-05

Barrquer  
Size 1,



SI-11-173-11

Elsching  
Size 1,



SI-11-174-11

Graefe  
Size 1,



SI-11-175-09

Lester  
Size 1,



SI-11-176-09

Castroviejo  
Size 1,



SI-11-178-09

Castroviejo  
Size 1,



SI-11-179-09

Barraquer  
Size 1,



SI-11-180-10

Green  
Size 1,



SI-11-181-07

Gill Arruga  
Size 1,



SI-11-182-01

Castroviejo  
Size 1,



**SI-11-183-05**

Castroviejo  
Size 1,



**SI-11-184-10**

Moorfield  
Size 1,



**SI-11-185-07**

St Martin  
Size 1,



**SI-11-186-10**

Mod Tubingen  
Size 1,



**SI-11-187-10**

McPherson  
Size 1,



**SI-11-188-10**

McPherson  
Size 1,



SI-11-189-09

Ayer  
Size 1,



SI-11-190-09

Ayer  
Size 1,



SI-11-191-09

Desmarres  
Size 1,



SI-11-192-10

Snellen  
Size 1,



SI-11-1193-11

Knapp Luer  
Size 1,



SI-11-194-28

Scheie  
Size 1,



SI-11-195-45

Mod Tubingen  
Size 1,



SI-11-196-00

Elliot  
Size 1,



SI-11-197-09

Beer  
Size 1,



SI-11-198-10

Barraquer



SI-11-199-09

Douglas  
Size 1,



SI-11-200-09

Gradle  
Size 1,



SI-11-177-09

Castroviejo  
Size 1,



SI-11-119-07

Mueller  
Size 1,

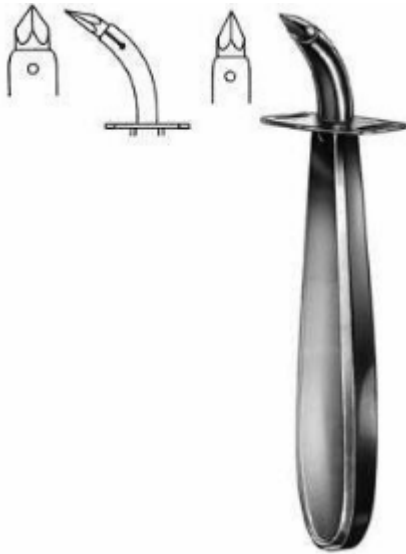

**SI-16-101-13**

**Weckermann**

Tracheotomy Trocar  
11.5 cm,



**SI-16-102-16**

**Iterson**

Tracheal Hook  
17 cm,



**SI-16-103-13**

**Rose**

Tracheal Hook  
13.5 cm,



**SI-16-104-11**

**Luer**

Tracheal Hook  
11 cm,



**SI-16-105-15**

Tracheal Hook  
15 cm,



**SI-16-106-17**

**Lukens**

Thymus Retractor  
17.5 cm,



**SI-16-107-17**

**Jackson**

Tracheal Hook  
18 cm,



**SI-16-108-15**

**Kocher**

Goitre Enucleator  
16.5 cm,



**SI-16-109-15**

**Kocher**

Goitre Enucleator  
16.5 cm,



**SI-16-110-21**

**Hofmeister**

Goitre Enucleator  
20.5 cm,

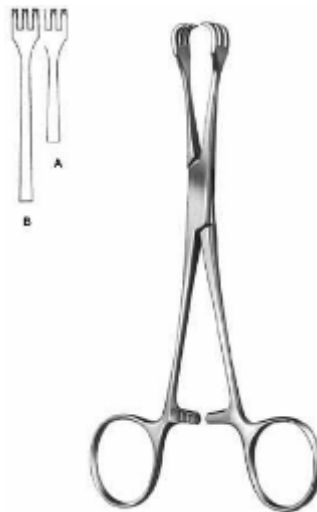

**SI-16-111-15**

**Lahey**

Goitre Grasping Forceps  
15.5 cm,



**SI-16-112-04**

**Luer**

Tracheal Tube





**SI-16-113-08**

**Luer**

Tracheal Tube



**SI-16-114-04**

**Chevalier-Jackson**

Tracheal Tube outer tube closed inner  
tube closed silver



**SI-16-115-08**

Speaking Tube



**SI-17-101-14**  
**Moncorps**  
Milium Knife  
14 cm,



**SI-17-102-00**  
**Moncorps**  
Spare Blade



**SI-17-103-14**  
**Vidal**  
Lupus Scraper  
13 cm,



**SI-17-105-01**  
**Wolff**  
Lupus Curette  
14 cm,



**SI-17-106-15**  
**Kilner**  
Skin Hooklet  
14.5 cm,



**SI-17-107-18**  
**Gillies**  
Skin Hooklet  
18 cm,



**SI-17-108-03**

**Kaye**

Face-lift Hook  
13 cm,

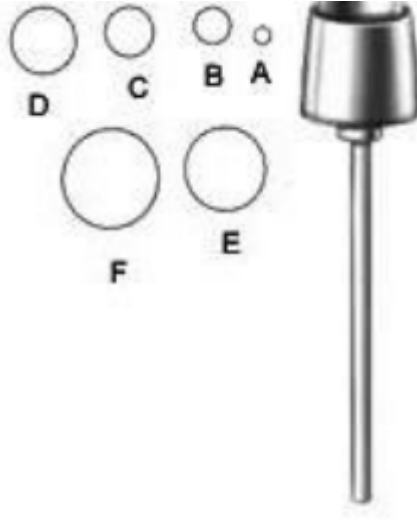

**SI-17-109-02**

Dermal Punch  
5.5 cm,



**SI-17-110-00**

**Handle**

8 cm,

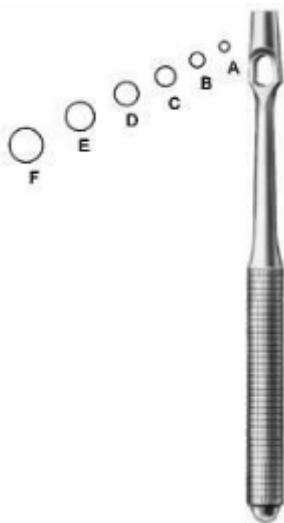

**SI-17-111-02**

**Keyes**

Dermal Punch  
11 cm,



**SI-17-113-14**

**Unna**

Comedone Extractor  
14.5 cm,



**SI-17-114-10**

**Saalfeld**

Comedone Extractor  
11 cm,



**SI-17-115-14**

**Saalfeld**

Saalfeld Comedone Extractor  
14.5 cm,



**SI-17-116-10**

**Schamberg**

Comedone Extractor  
9.5 cm,



**SI-17-117-14**

**Katsch**

Comedone Extractor  
16 cm,

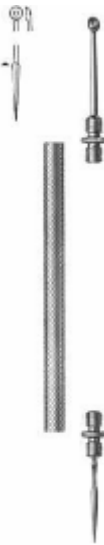

**SI-17-118-11**

**Unna-Vidal**

Comedone Extractor  
11.5 cm,



**SI-17-119-15**

**d'Assump?**

Face-lift Forceps  
18 cm,



**SI-17-120-14**

**Gregory**

Face-lift Scissors  
14 cm,



**SI-17-121-15**

**Kaye**

Face-lift Scissors  
15 cm, 18 cm,



**SI-17-122-18**

**Stella-S**

Face-lift Scissors  
18 cm,



**SI-17-123-18**

**Gorney**

Face-lift Scissors  
18 cm,



**SI-17-124-18**

**Freeman-Kaye**

Face-lift Scissors  
18 cm,



**SI-17-125-00**

**Freeman**

Face-lift Scissors  
23 cm,



**SI-17-104-01**

**Fox**

Lupus Curette  
14 cm,



**SI-17-112-14**

**Unna**

Comedone Extractor  
14.5 cm,



**SI-18-101-12**

**Allis-Baby**

Intestinal and Tissue Grasping Forceps  
13 cm,

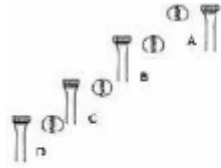

**SI-18-102-15**

**Allis**

Intestinal and Tissue Grasping Forceps  
15.5 cm, 19 cm, 25.5 cm,



**SI-18-103-16**

**Allis**

Intestinal and Tissue Grasping Forceps  
15.5 cm, 20 cm, 24.5 cm, 30 cm,



**SI-18-104-15**

**Allis-Adair**

Intestinal and Tissue Grasping Forceps  
16 cm,



**SI-18-105-15**

**Boys-Allis**

Intestinal and Tissue Grasping Forceps  
15.5 cm,



**SI-18-106-20**

**Thoms-Allis**

Intestinal and Tissue Grasping Forceps  
20.5 cm,



**SI-18-107-20**

**Allis**

Intestinal and Tissue Grasping Forceps  
20 cm,



**SI-18-108-20**

**Lockwood**

Intestinal and Tissue Grasping Forceps  
20 cm,



**SI-18-109-16**

**Williams**

Intestinal and Tissue Grasping Forceps  
16.5 cm,

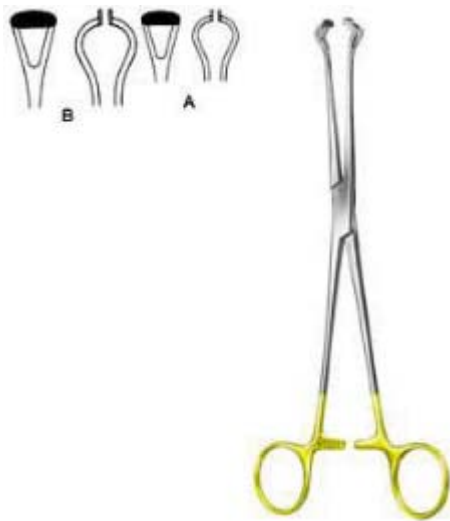

**SI-18-110-16**

**Babcock**

Intestinal and Tissue Grasping Forceps  
16.5 cm, 21 cm,

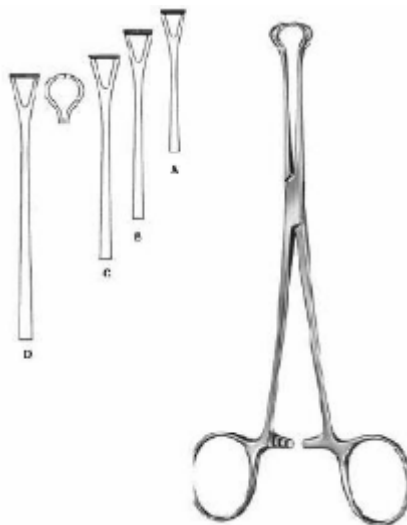

**SI-18-111-16**

**Babcock**

Intestinal and Tissue Grasping Forceps  
15.5 cm, 17.5 cm, 21 cm, 24 cm,

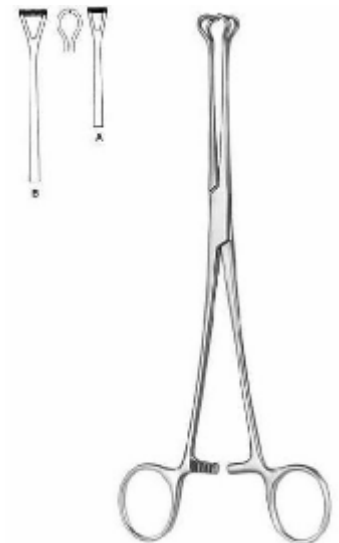

**SI-18-112-16**

**Babcock**

Intestinal and Tissue Grasping Forceps  
16 cm, 20.5 cm,





**SI-18-113-20**

**Duval**

Intestinal and Tissue Grasping Forceps  
20.5 cm,

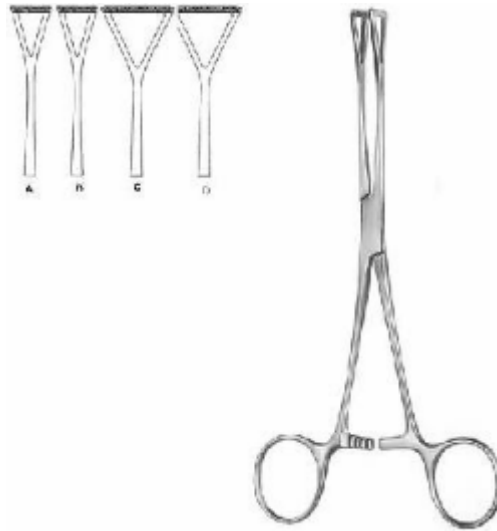

**SI-18-114-18**

**Duval**

Intestinal and Tissue Grasping Forceps  
18 cm, 20.5 cm, 23 cm,

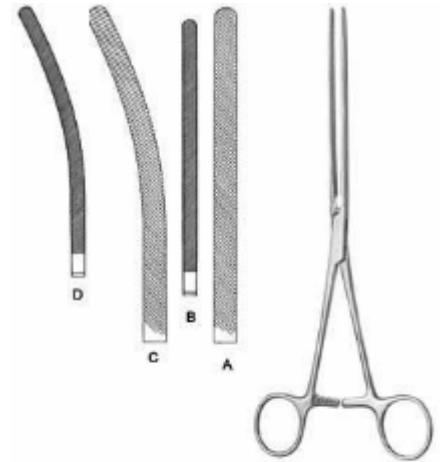

**SI-18-115-21**

**Doyen**

Intestinal Clamp  
21.5 cm, 23.5 cm,



**SI-18-116-18**

**Doyen-Baby**

Intestinal Clamp  
18 cm, 17.5 cm,



**SI-18-117-21**

**Mayo-Robson**

Intestinal Clamp  
21.5 cm, 23.5 cm, 23 cm,

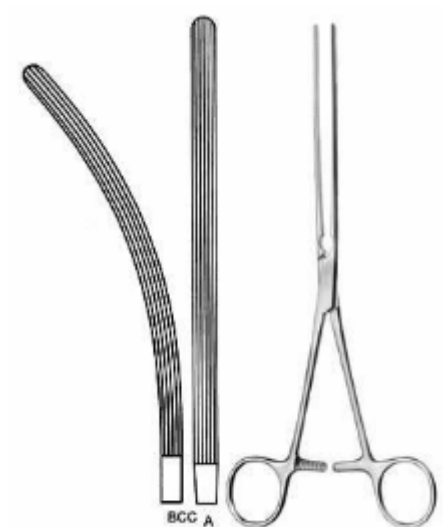

**SI-18-118-25**

**Mayo-Robson**

Intestinal Clamp  
25.5 cm, 24.5 cm,

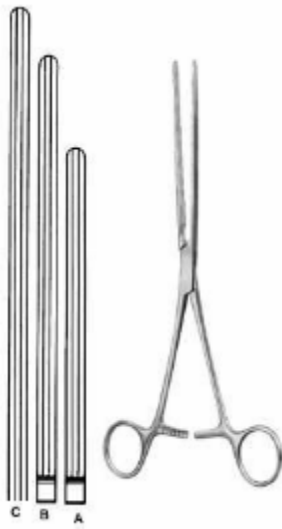

**SI-18-119-22**

**Kocher**

Intestinal Clamp  
22.5 cm, 25 cm, 28.5 cm,

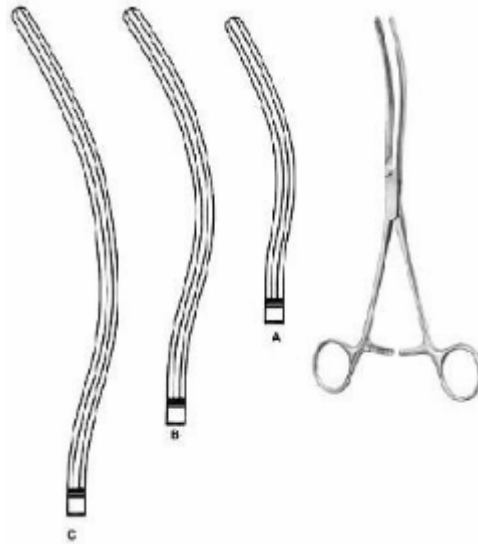

**SI-18-120-22**

**Kocher**

Intestinal Clamp  
22 cm, 24.5 cm, 27.5 cm,



**SI-18-121-16**

**Allen**

Intestinal Clamp  
16 cm,



**SI-18-122-15**

**Payr-Baby**

Intestinal and Pylorus Clamp  
15 cm,

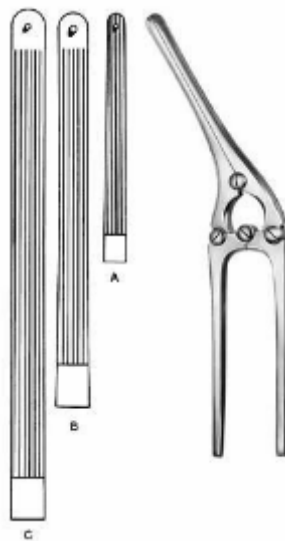

**SI-18-123-21**

**Payr**

Intestinal and Pylorus Clamp  
20.5 cm, 29 cm, 34.5 cm,



**SI-18-124-07**

**Stone-Watt**

Intestinal Anastomosis Clamp  
8.5 cm, 10 cm,



**SI-18-125-15**  
**Stone-Watt**  
Closing Forceps

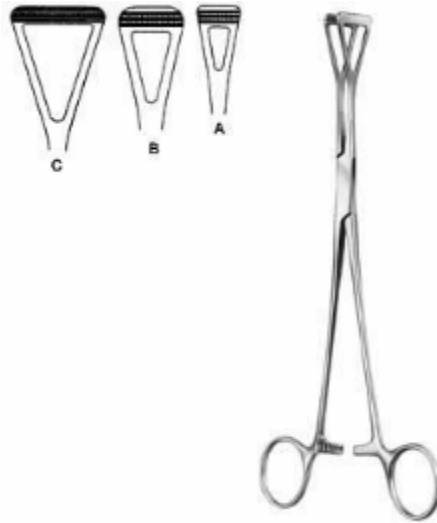

**SI-18-126-18**  
**Scheibe**  
Organ Grasping Forceps  
18 cm,

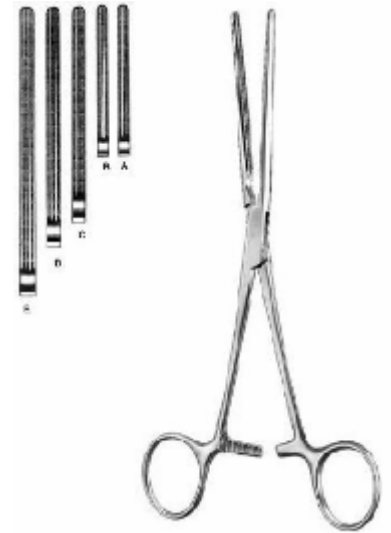

**SI-18-127-13**  
**Doyen-Baby**  
Intestinal Clamp  
14 cm, 17 cm,

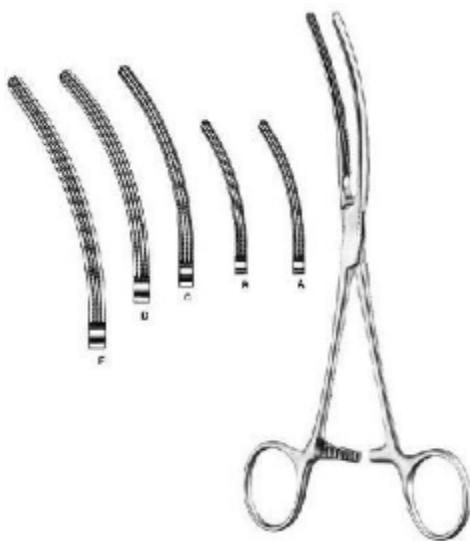

**SI-18-128-13**  
**Doyen-Baby**  
Intestinal Clamp  
13.5 cm, 17 cm,



**SI-18-129-25**  
**Mayo-Robson**  
Intestinal Clamp  
26 cm,



**SI-18-130-25**  
**Mayo-Robson**  
Intestinal Clamp  
25 cm,



**SI-18-131-22**

**Kocher**

Intestinal Clamp  
22.5 cm, 28 cm,



**SI-18-132-22**

**Kocher**

Intestinal Clamp  
22 cm, 25 cm, 27.5 cm,

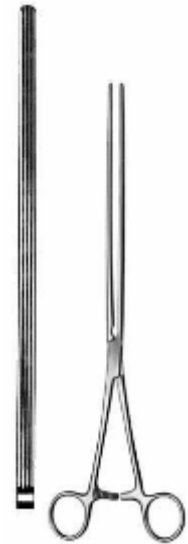

**SI-18-133-33**

**Scudder**

Intestinal Clamp  
33.5 cm,

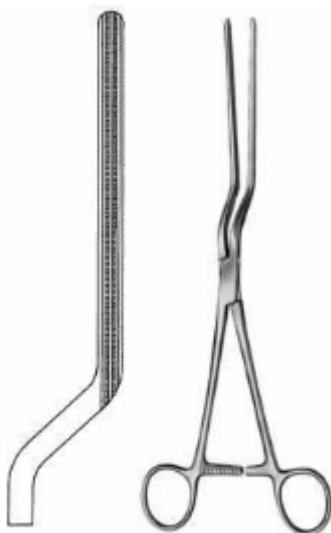

**SI-18-134-24**

**Brunner**

Sigmoid Anastomosis Forceps  
27 cm,



**SI-18-135-26**

**Hayes**

Sigmoid Anastomosis Forceps  
27 cm, 28 cm,



**SI-18-136-23**

**Veidenheimer**

Sigmoid Anastomosis Forceps  
25 cm,



**SI-18-137-24**

**Fehland**

Sigmoid Anastomosis Forceps  
24 cm,



**SI-18-138-30**

**Resano**

Sigmoid Anastomosis Forceps  
28 cm,



**SI-18-139-15**

**Sims**

Rectal Speculum  
15.5 cm,



**SI-18-140-15**

**Sims**

Rectal Speculum  
15.5 cm,



**SI-18-141-19**

**Mathieu**

Rectal Speculum  
19 cm,



**SI-18-142-00**

**Alan-Parks**

Alan-Parks  
14 cm,



**SI-18-143-19**

**McGinvey**

Hemorrhoidal Grasping Forceps  
19 cm,



**SI-18-144-00**

Handle for biopsy forceps



**SI-18-145-38**

Rectal Biopsy Forceps

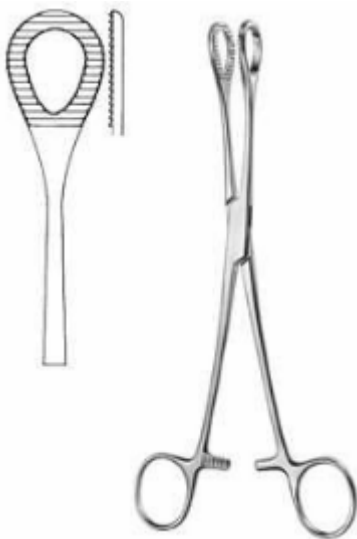

**SI-18-146-21**

**Heywood-Smith**

Polypus Grasping Forceps  
21 cm,



**SI-20-101**

**Cusco**

Vaginal Speculum  
75 x 32 mm, 85 x 35 mm,



**SI-20-102-01**

**Cusco**

Vaginal Speculum  
75 x 18 mm,



**SI-20-103-01**

**Cusco**

Vaginal Speculum  
80 x 22 mm, 100 x 25 mm, 105 x 27 mm,



**SI-20-104-01**

**Cusco**

Vaginal Speculum  
75 x 34 mm, 85 x 37 mm,



**SI-20-105-01**

**Collin**

Vaginal Speculum  
85 x 30 mm, 100 x 35 mm,



**SI-20-106-01**

**Pederson**

Vaginal Speculum  
75 x 13 mm, 100 x 22 mm,







**SI-20-107-01**

**Grave**

Vaginal Speculum  
75 x 20 mm, 95 x 35 mm,



**SI-20-108-01**

**Semm**

Vaginal Speculum  
100 x 20 mm, 105 x 27 mm,



**SI-20-109-01**

**Sims**

Vaginal Speculum  
65 x 25 mm, 70 x 30 mm,



**SI-20-110-01**

**Kristeller**

Vaginal Speculum  
70 x 27 mm,



**SI-20-111-01**

**Kristeller**

Vaginal Retractor  
75 x 23 mm,



**SI-20-112-01**

**Kristeller**

Vaginal Speculum  
Size 1,



**SI-20-113-01**

**Kristeller**

Vaginal Speculum  
105 x 18 mm,



**SI-20-114-01**

**Kristeller**

Vaginal Retractor  
110 x 14 mm,



**SI-20-115-01**

**Kristeller**

Vaginal Speculum  
Size 1,

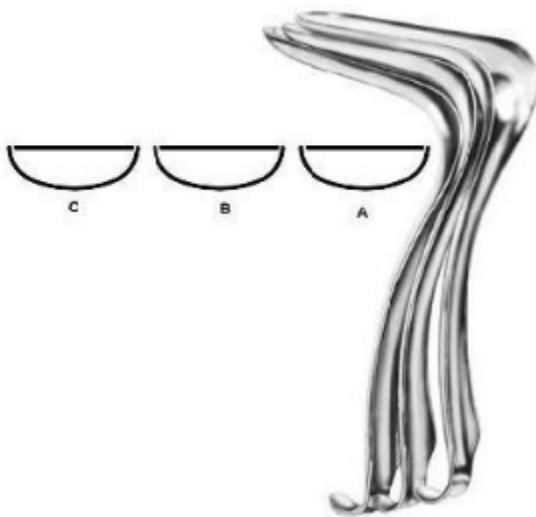

**SI-20-116-01**

**Kristeller**

Vaginal Speculum  
105 x 26 mm,

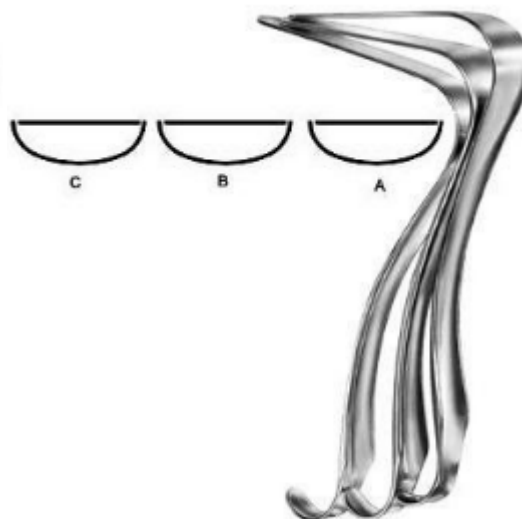

**SI-20-117-01**

**Kristeller**

Vaginal Retractor  
115 x 22 mm, 115 x 24 mm,

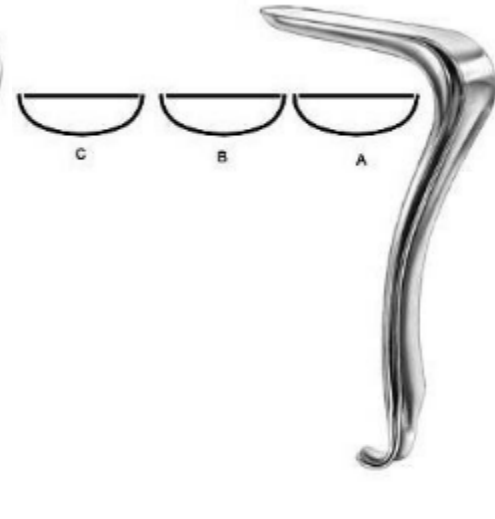

**SI-20-118-01**

**Kristeller**

Vaginal Speculum  
Size 1,

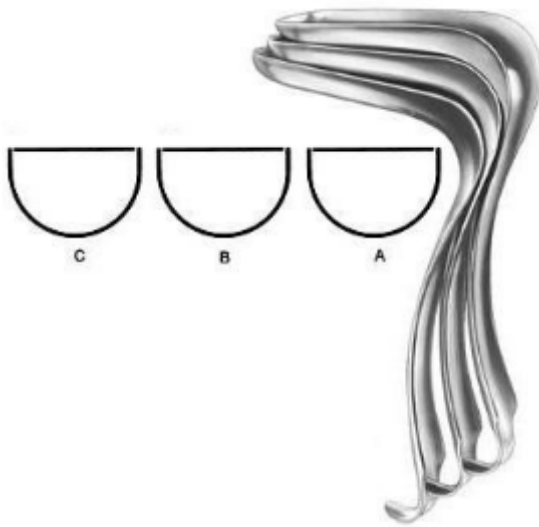

**SI-20-119-01**

**Kristeller**

Vaginal Speculum  
110 x 27 mm,

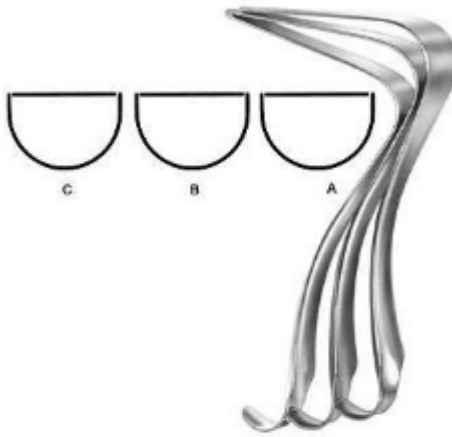

**SI-20-120-01**

**Kristeller**

Vaginal Retractor  
115 x 23 mm,



**SI-20-121-01**

**Kallmorgen**

Vaginal Speculum



**SI-20-122-01**

**Kallmorgen**

Vaginal Retractor  
70 x 40 mm Fig. 1, 90 x 40 mm Fig. 2,



**SI-20-123-01**

**Kallmorgen**

Vaginal Speculum  
70 x 33 mm, 90 x 33 mm,

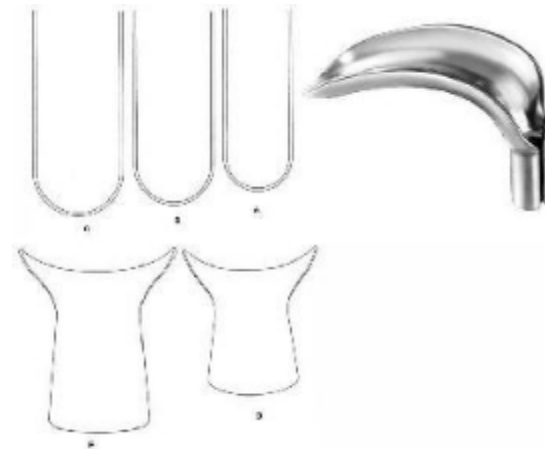

**SI-20-125-00**

**Scherbak**

Vaginal Speculum  
Size 1,



**SI-20-126-22**

**Auvard**

Vaginal Speculum  
80 x 43 mm,



**SI-20-127-24**

**Weissbarth**

Vaginal Speculum  
21 cm 80 x 42 mm,



**SI-20-128-20**

**Breisky**

Vaginal Speculum  
29 cm 100 x 20 mm, 29 cm 100 x 25 mm,



**SI-20-129-24**

**Kogan**

Endocervical Speculum  
25 cm 70 x 30 mm,



**SI-20-130-24**

**Kogan**

Endocervical Speculum  
24.5 cm,



**SI-20-131-24**

**Hegar**

Uterine Dilator  
18.5 cm 1,0,



**SI-20-132-02**

**Hegar**

Uterine Dilator  
20 cm 1,0,



**SI-20-133-10**

**Hank**

Uterine Dilator  
26.5 cm Fig. 9/10,



**SI-20-134-32**

**Sims**

Uterine Sound  
33 cm,



**SI-20-135-25**

**Valleix**

Uterine Sound  
29.5 cm,



**SI-20-136-26**

**Braun**

Uterine Depressor  
27.5 cm,



**SI-20-137-25**

**Schroder**

Uterine Tenaculum Forceps  
25.5 cm,



**SI-20-138-25**

**Braun**

Uterine Tenaculum Forceps  
26 cm,



**SI-20-139-28**

**Duplay**

Uterine Tenaculum Forceps  
25.5 cm,



**SI-20-140-26**

**Beacham**

Amniotome  
26 cm,



**SI-20-141-24**

**Skene**

Uterine Tenaculum Forceps  
24 cm,

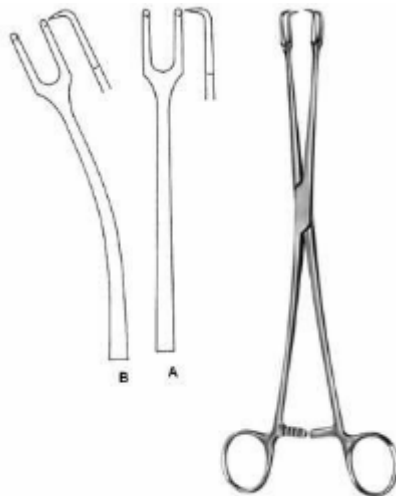

**IN-20-142-24**

**Schroder**

Uterine Tenaculum Forceps  
25 cm,



**SI-20-143-23**

**Teale**

Uterine Tenaculum Forceps  
23.5 cm,



**SI-20-144-26**

**Iowa**

Uterine Tenaculum Forceps  
26 cm,



**SI-20-145-24**

**Museux**

Uterine Tenaculum Forceps  
24 cm,



**SI-20-146-21**

**Jacobs**

Uterine Tenaculum Forceps  
21 cm,

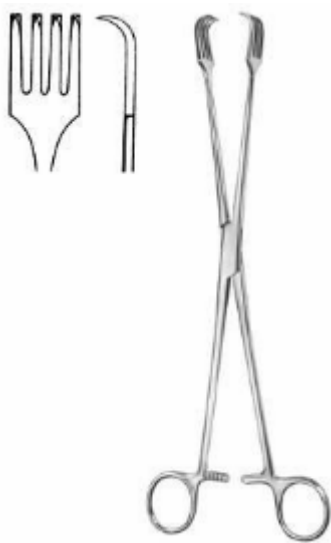

**SI-20-147-26**

Uterine Tenaculum Forceps  
26.5 cm,



**SI-20-148-16**

**Braun**

Uterine Tenaculum Forceps  
16 cm,

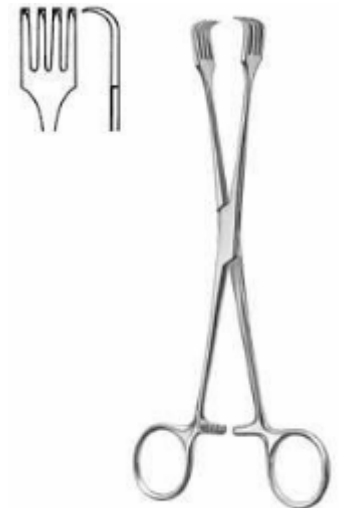

**SI-20-149-21**

**Czerny**

Uterine Tenaculum Forceps  
21 cm,



**SI-20-150-32**

**Kelly**

Uterine Polypus Forceps  
32 cm,



**SI-20-151-27**

**Noto**

Uterine Polypus Forceps  
27 cm,

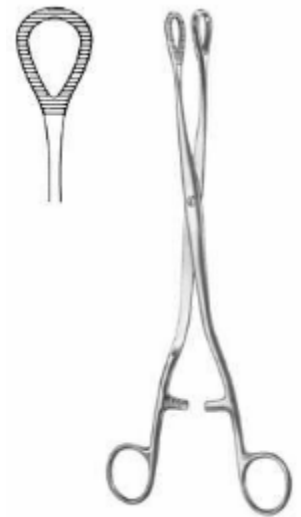

**SI-20-152-25**

**Heywood-Smith**

Uterine Polypus Forceps  
25 cm,



**SI-20-153-17**

**Doyen**

Myoma Screw  
17 cm,



**SI-20-154-17**

**Doyen**

Myoma Screw  
14.5 cm,



**SI-20-155-27**

**Segond**

Myoma Knife  
28 cm,





**SI-20-156-27**

**Dartigues**

Uterine Seizing Forceps  
28 cm,



**SI-20-157-27**

**Somer**

Uterine Seizing Forceps  
22.5 cm,



**SI-20-158-25**

**Collin**

Uterine Seizing Forceps jaw 40 mm wide  
26 cm,



**SI-20-159-23**

**Ayre**

Conization Knife cutting edge 3,6 mm  
wide  
23.5 cm,



**SI-20-160-03**

**Emmett**

Fistula Hook  
22 cm Fig.3,



**SI-20-161-22**

**Simon**

Fistula Hook  
21.5 cm,



**SI-20-162-22**

**Simon**

Fistula Hook  
21.5 cm,



**SI-20-163-23**

**Novak**

Suction Curette 4 mm ?  
24.5 cm,



**SI-20-164-23**

**Kevorkian**

Uterine Biopsy Curette 6,0 mm ?  
30 cm,



**SI-20-165-27**

**Munchen**

Uterine Biopsy Curette 4,8 mm ?  
27 cm,



**SI-20-166-23**

**Gellhorn**

Uterine Biopsy Forceps jaw 8,6 mm wide  
24 cm,



**SI-20-167-21**

**Faure**

Faure Uterine Biopsy Forceps  
21 cm,



**SI-20-168-21**

**Schubert**

Uterine Biopsy Forceps jaw 4,8 mm wide  
21.5 cm, 28 cm,



**SI-20-169-22**

**Thoms-Gaylor**

Uterine Biopsy Forceps jaw 5,6 mm ?  
21 cm, 23.5 cm,

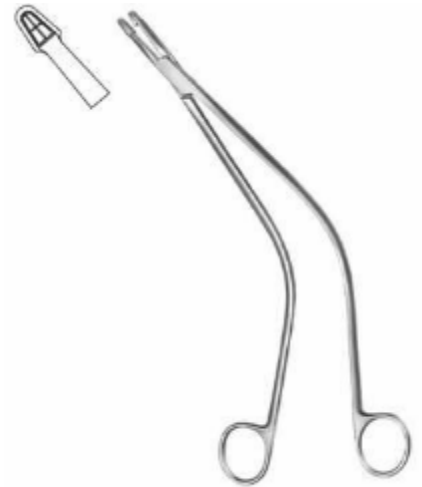

**SI-20-170-26**

**Schubert**

Schubert Uterine Biopsy Forceps  
25.5 cm,

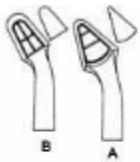

**SI-20-171-24**

**Van Doren**

Uterine Biopsy Forceps jaw 4,9 mm wide  
27 cm, 25.5 cm,



**SI-20-172-28**

**Alexander**

Uterine Biopsy Forceps jaw 5,1 mm wide  
28 cm,



**SI-20-173-32**

**Kevorkian**

Uterine Biopsy Forceps  
25 cm,

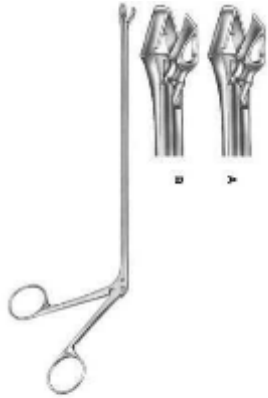

**SI-20-174-01**

**Schumacher**

Uterine Biopsy Forceps jaw 4,6 / 5,4 mm wide  
24 cm,



**SI-20-175-00**

**Schumacher**

Uterine Biopsy Forceps  
25 cm,



**SI-20-176-22**

IUP Grasping Forceps 3 mm ?  
22 cm,

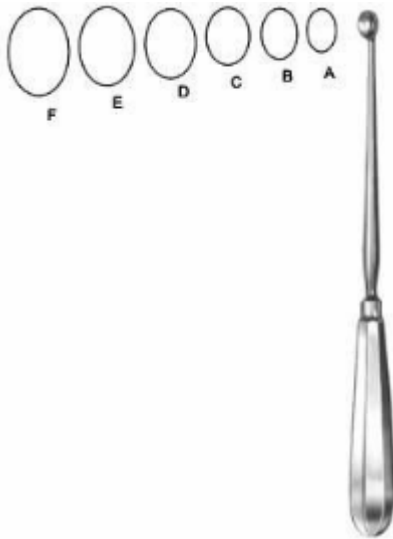

**SI-20-177-01**

**Simon**

Uterine Scoop  
24.5 cm 9,8 x 8,6 mm, 24.5 cm 11,6 x 8,3 mm,



**SI-20-178-01**

**Simon**

Uterine Scoop  
30 cm 9,8 x 8,6 mm, 30 cm 11,6 x 8,3 mm,



**SI-20-179-05**

**Recamier**

Uterine Curette  
31 cm Fig. 00 5 mm, 31 cm Fig. 0 6 mm,



**SI-20-180-05**

**Recamier**

Uterine Curette

31 cm Fig. 00 5 mm, 31 cm Fig. 0 6 mm,



**SI-20-181-05**

**Sims**

Uterine Curette

31 cm Fig. 00 5 mm, 31 cm Fig. 0 6 mm,



**SI-20-182-05**

**Sims**

Uterine Curette

31 cm Fig. 00 5 mm, 31 cm Fig. 0 6 mm,



**SI-20-183-03**

Suction Curette

29 cm 3,0 mm ?, 29 cm 4,5 mm ?, 29 cm  
6,0 mm ?,



**SI-21-101-34**

**Martin**

Pelvimeter cm, inch scale  
34 cm,



**SI-5-102-36**

**Nagele**

Obstetrical Forceps  
35 cm, 40.5 cm,



**SI-5-103-30**

**Simpson**

Obstetrical Forceps  
31 cm,



**SI-5-104-28**

**Wrigley**

Obstetrical Forceps  
28 cm,



**SI-21-105-36**

**Simpson**

Obstetrical Forceps  
36.5 cm,



**SI-21-106-41**

**Kielland**

Obstetrical Forceps  
42 cm,

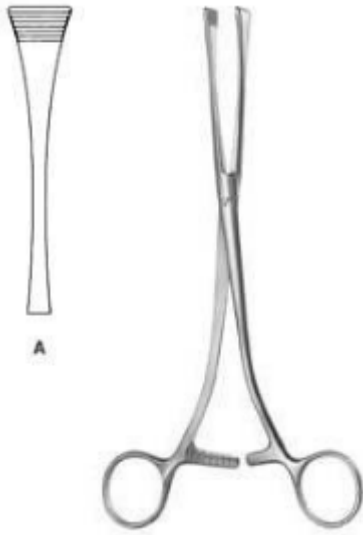

**SI-21-107-21**  
**Green-Armytage**  
 Uterine Clamp  
 21 cm,



**SI-21-108-28**  
**Sellheim**  
 Obstetrical Lever  
 32 cm,

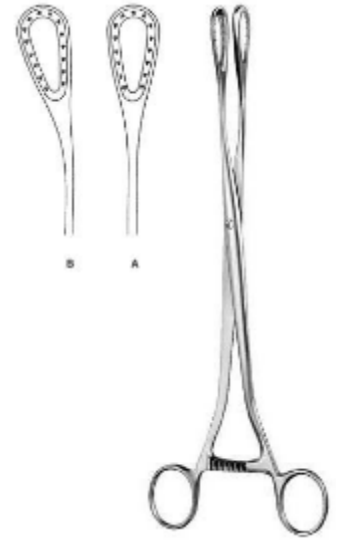

**SI-21-109-27**  
**Sanger**  
 Placenta and Ovum Forceps  
 27.5 cm, 27 cm,

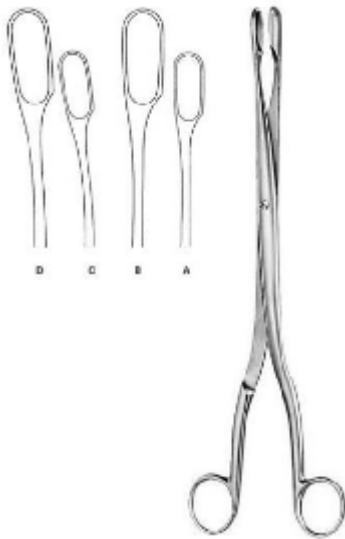

**SI-21-110-01**  
**Winter**  
 Placenta and Ovum Forceps  
 28 cm Fig. 1, 28 cm Fig. 2,

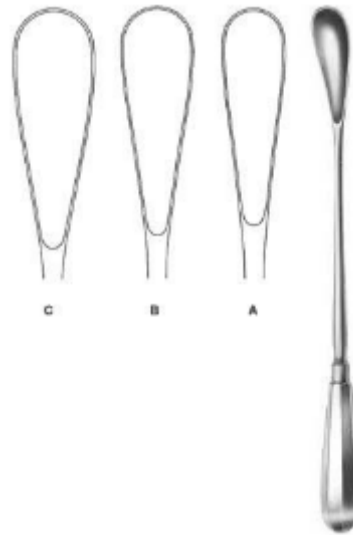

**SI-21-111-01**  
**Cuzzi**  
 Placenta Scoop  
 30 cm 14,5 mm, 30 cm 18 mm,



**SI-21-112-30**  
**Pestalozza**  
 Placenta Scoop  
 30 cm,



**SI-21-113-08**

**Kane**

Umbilical Cord Clamp  
8.5 cm,



**SI-21-114-09**

**Collin**

Umbilical Cord Clamp  
8.5 cm,





**SI-23-101-10**

**Irrigator**

Size 1,



**SI-23-102-16**

**Round Bowl**

220 mm x 70 mm, 400 mm x 150 mm,



**SI-23-103-33**

**Round Bowl**

? x h 6,00 l,



**SI-23-104-11**

**Flat Dish**

? x h 0,20 l,



**SI-23-105-11**

**Lid only**

Size 1,



**SI-23-106-04**

**Stainless Steel**

? x h 0,30 l,



**SI-23-107-11**

**Round Dish**

? x h 0,30 l, ? 128 x 38 mm 0,40 l,



**SI-23-108-11**

**Flat Dish**

? x h 0,15 l,



**SI-23-109-01**

**Measurer**

graduated inside  
100cc = 0,1 l,



**SI-23-110-02**

**Measurer**

Graduated Inside  
0,25 l, 0,50 l,



**SI-23-111-10**

**Petri Dish**

with Lid ? x h



**SI-23-112-09**

**Petri Dish**

without lid ? x h  
Size 1,



**SI-23-113-10**  
**Lid for Petri Dishes**  
Size 1,



**SI-23-114-23**  
**Universal Tray**  
l x b x h,



**SI-23-115-21**  
**Instrument Tray**  
l x b x h,



**SI-23-116-23**  
**Universal Tray**  
l x b x h,



**SI-23-117-22**  
**Round Bowl**  
? x h,



**SI-23-118-30**  
**Metal Jar**  
? 30mm x 90 mm, ? 50mm x 100 mm,



**SI-23-119-16**

**Instrument Box**

lid with knob  
l x b x h,



**SI-23-120-16**

**Instrument Box**

lid with knob  
l x b x h,



**SI-23-121-20**

**Instrument Box**

l x b x h,



**SI-23-122-06**

**Round Metal Box**

? 75 mm x 75 mm, ? 100 mm x 60 mm,



**SI-23-123-25**

**Medicine Cup Graduated Inside**

25 ccm,



**SI-23-124-50**

**Medicine Cup Graduated Inside**

50 ccm,



**SI-23-125-75**

**Tablet Tray**

? 75 mm x 12 mm,



**SI-23-126-90**

**Metal Cup**

? 90 mm x 90 mm,



**SI-23-127-75**

**Denture Cup**

? 75 mm x 50 mm,



**SI-23-128-75**

**Insert for Cup**

? 73 mm x 75 mm,



**SI-23-129-17**

**Kidney Dish**

l x b x h,



**SI-23-130-36**

**Placenta Pan**

Size 1,



**SI-23-131-01**

**Waste Cotton Collector**

? 50 mm x 75 mm,



**SI-23-132-07**

**Spirit Lamp**

120 ccm,



**SI-7-102-35**

**Charrière**

Amputation Saw  
35 cm,



**SI-7-103-23**

**Langenbeck**

Amputation Saw  
24.5 cm,



**SI-7-104-27**

**Charrière**

Amputation Saw  
26.5 cm,



**SI-7-105-14**

Reamer  
13.5 cm,



**SI-7-106-18**

**Perthes**

Reamer  
18 cm,

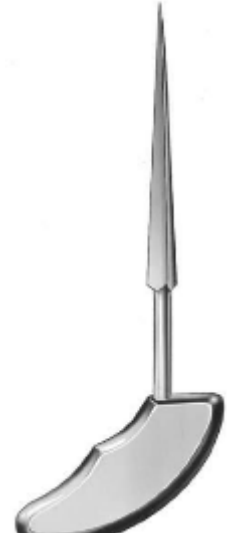

**SI-7-107-21**

**Perthes**

Reamer  
21.5 cm,



**SI-7-108-14**

Reamer  
14 cm,



**SI-7-111-18**

Flat Trephine



**SI-7-112-01**

Wire Twisting Forceps  
15.5 cm, 18 cm, 20 cm,



**SI-7-113-15**

Wire Twisting Forceps  
15.5 cm,



**SI-7-114-17**

Flat Nose Plier  
18.5 cm,



**SI-7-115-18**

Wire Twisting Forceps  
19 cm,





**SI-7-116-15**

Combi-Flat Nose Plier  
15 cm,



**SI-7-117-01**

Flat Nose Plier  
18 cm,

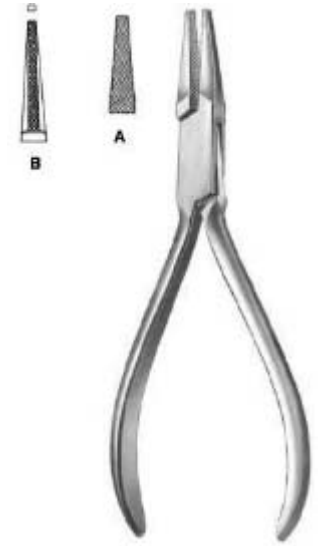

**SI-7-118-14**

Flat Nose Plier  
13.5 cm,



**SI-7-119-16**

**Hackstock**

Flat Nose Plier  
16 cm,



**SI-7-120-01**

Flat Nose Plier  
17.5 cm,



**SI-7-121-18**

Wire Cutting Pliers  
18.5 cm,



**SI-7-122-15**

Wire Cutting Pliers  
15 cm,



**SI-7-123-18**

Wire Cutting Pliers  
17.5 cm,



**SI-7-124-18**

**Demel**  
Wire Guide  
31 cm Fig. 1, 29 cm Fig. 2, 28 cm Fig. 3,

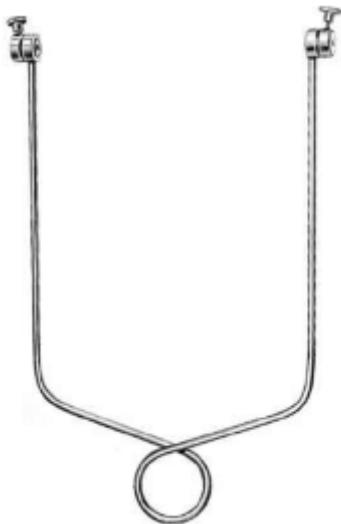

**SI-7-125-15**

**Bohler**  
Extension Bow



**SI-7-126-01**

**Kirschner**  
Extension Bow  
18.5 cm, 26.5 cm,



**SI-7-127-06**

Traction Hook for Extension Bows



**SI-7-128-06**  
**Kirschner**  
Wire Drill  
6 cm, 12 cm,



**SI-7-129-06**  
**Kirschner**  
Wire Drill  
14 cm, 16 cm,



**SI-7-130-10**  
**Kirschner**  
Wire Drill  
31 cm,



**SI-7-131-10**  
**Kirschner**  
Wire Drill  
6 cm, 12 cm, 18 cm,



**SI-7-132-10**  
**Kirschner**  
Wire Drill  
31 cm,



**SI-7-133-02**  
**Buckley**  
Chisel  
16 cm,



**SI-7-134-02**

**Buckley**

Gouge  
16 cm,



**SI-7-135-03**

**Stout**

Bone Chisel  
21 cm,



**SI-7-136-04**

Bone Chisel  
18 cm,



**SI-7-137-04**

Bone Chisel  
18 cm,



**SI-7-138-04**

Bone Chisel  
17 cm,



**SI-7-139-04**

Bone Chisel  
17 cm,

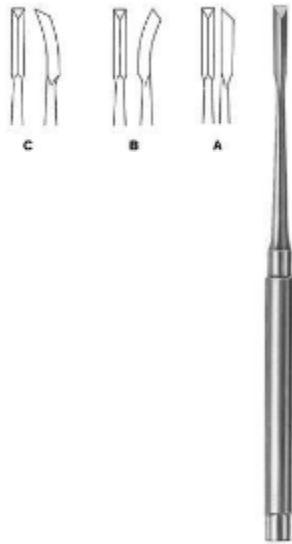

**SI-7-140-01**

**Gardner**

Bone Chisel  
17 cm 4mm,



**SI-7-141-03**

**Snyder-O.S.U.**

Bone Chisel  
16.5 cm 3mm, 16.5 cm 5.5mm,



**SI-7-142-01**

**O.S.U.**

one Chisel  
17 cm 7mm,



**SI-7-143-01**

**O.S.U.**

one Chisel  
17 cm 9mm,



**SI-7-144-08**

**Osteotome**

13.5 cm 8mm, 13.5 cm 10mm, 13.5 cm  
12mm, 13.5 cm 14mm, 13.5 cm 16mm,



**SI-7-145-08**

**Chisel**

13.5 cm 8mm, 13.5 cm 10mm, 13.5 cm  
12mm, 13.5 cm 14mm, 13.5 cm 16mm,



**SI-7-146-08**

Gouge

13.5 cm 8mm, 13.5 cm 10mm, 13.5 cm 12mm, 13.5 cm 14mm, 13.5 cm 16mm,



**SI-7-147-02**

Partsch

Chisel

13.5 cm 2mm, 13.5 cm 3mm, 13.5 cm 4mm, 13.5 cm 5mm, 13.5 cm 6mm, 17 cm 2mm, 17 cm 3mm, 17 cm 4mm, 17 cm 5mm, 17 cm 6mm,



**SI-7-148-02**

Partsch

Gouge

13.5 cm 2mm, 13.5 cm 3mm, 17 cm 2mm, 17 cm 3mm,



**SI-7-149-10**

Stille

Chisel

20 cm 10mm, 20 cm 15mm, 20 cm 20mm, 20 cm 25mm,



**SI-7-150-10**

Stille

Osteotome

20 cm 10mm, 20 cm 15mm, 20 cm 20mm, 20 cm 25mm,



**SI-7-151-10**

Stille

Gouges

20 cm 10mm, 20 cm 15mm, 20 cm 20mm, 20 cm 25mm,



**SI-7-152-02**

**Lambotte, Mini**

Osteotome

12.5 cm 2mm, 12.5 cm 3mm, 12.5 cm 4mm, 12.5 cm 6mm, 12.5 cm 8mm,



**SI-7-153-15**

**Lambotte**

Osteotome

24 cm 15mm, 24 cm 20mm, 24 cm 25mm, 24 cm 30mm,



**SI-7-154-15**

**Lambotte**

Osteotome

24 cm 15mm, 24 cm 20mm, 24 cm 25mm, 24 cm 30mm,



**SI-7-155-06**

**Smith-Petersen**

Osteotome

20.5 cm 6mm, 20.5 cm 9mm, 20.5 cm 13mm,



**SI-7-156-06**

**Smith-Petersen**

Osteotome

20.5 cm 6mm, 20.5 cm 9mm, 20.5 cm 13mm, 20.5 cm 16mm, 20.5 cm 19mm,



**SI-7-157-09**

**Smith-Petersen**

Gouge

20.5 cm 9mm, 20.5 cm 14mm, 20.5 cm 19mm, 20.5 cm 25mm,



**SI-7-158-09**

**Smith-Petersen**

Gouge

20.5 cm 9mm, 20.5 cm 14mm, 20.5 cm 19mm,



**SI-7-159-03**

**Hoke**

Osteotome

17 cm 3mm, 17 cm 5mm, 17 cm 6mm, 17 cm 8mm,

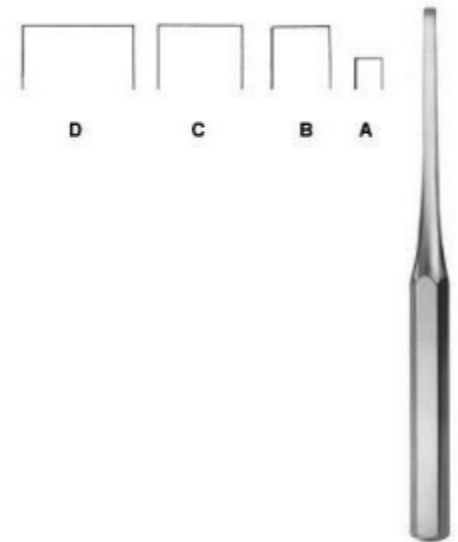

**SI-7-160-06**

**Hibbs**

Osteotome

24.5 cm 6mm, 24.5 cm 13mm, 24.5 cm 19mm,

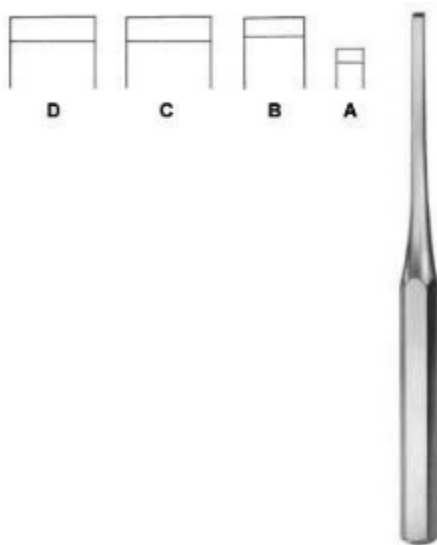

**SI-7-161-06**

**Hibbs**

Chisel

24.5 cm 6mm, 24.5 cm 19mm, 24.5 cm 13mm,

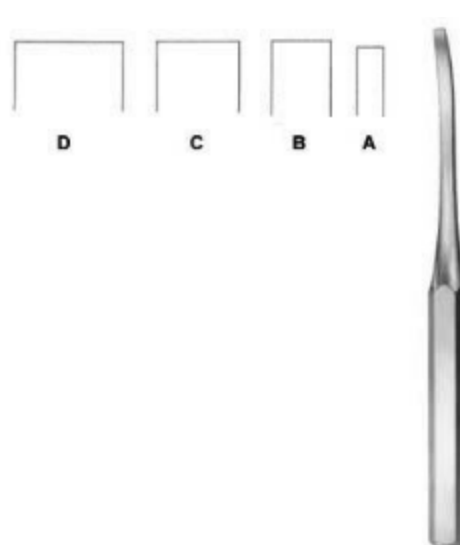

**SI-7-162-06**

**Hibbs**

Osteotome

24.5 cm 6mm, 24.5 cm 13mm, 24.5 cm 19mm,

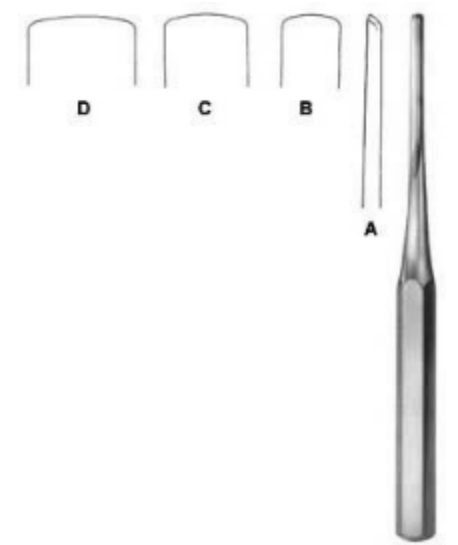

**SI-7-163-06**

**Hibbs**

Hibbs

24.5 cm 6mm, 24.5 cm 13mm, 24.5 cm 19mm,





**SI-7-164-06**

**Hibbs**

Gouge

24.5 cm 6mm, 24.5 cm 13mm, 24.5 cm 19mm,

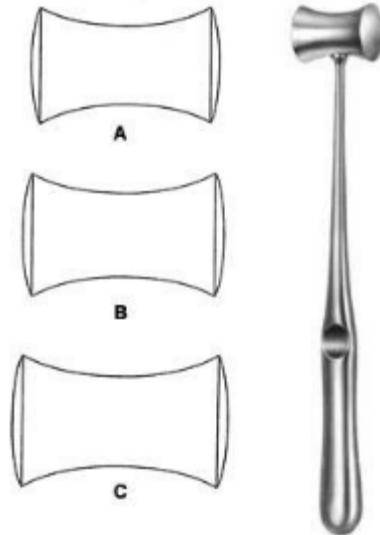

**SI-7-165-01**

**Williger**

Mallet

24 cm,

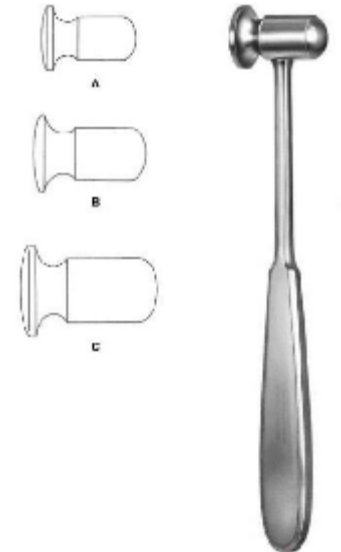

**SI-7-166-01**

**Doyen**

Mallet

20.5 cm, 21 cm, 21.5 cm,



**SI-7-167-20**

**Collin**

Mallet

20 cm,

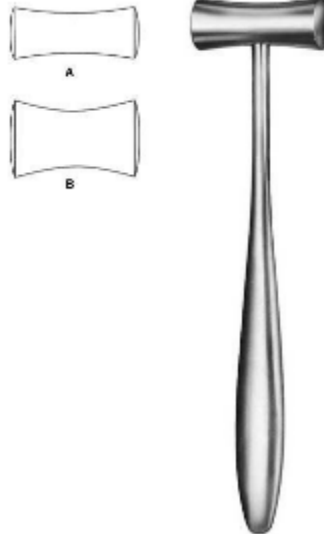

**SI-7-168-01**

**Lucae**

Mallet

19.5 cm,



**SI-7-169-19**

**Cottle**

Mallet

19 cm,



**SI-7-170-01**

**Williger**

Mallet  
16.5 cm,



**SI-7-171-17**

**Mead**

Mallet  
19 cm,



**SI-7-172-18**

**Partsch**

Mallet  
19 cm,



**SI-7-173-01**

**Schede**

Bone Curette Fig. 0 to 4  
17 cm,

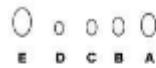

**SI-7-174-01**

**Volkmann**

Bone Curette  
17 cm Fig. 0, 17 cm Fig. 00, 17 cm Fig. 000, 17 cm Fig. 1, 17 cm Fig. 2, 17 cm Fig. 3, 17 cm Fig. 4,



**SI-7-175-01**

**Bruns**

Bone Curette  
17 cm Fig. 0, 17 cm Fig. 00, 17 cm Fig. 000, 17 cm Fig. 1, 17 cm Fig. 2, 17 cm Fig. 3, 17 cm Fig. 4,



**SI-7-176-01**

**Spratt**

Bone Curette

17 cm Fig. 0, 17 cm Fig. 00, 17 cm Fig. 000, 17 cm Fig. 0000, 17 cm Fig. 1, 17 cm Fig. 2, 17 cm Fig. 3, 17 cm Fig. 4, 17 cm Fig. 5,



**SI-7-177-01**

**Bruns**

Bone Curette

23 cm Fig. 0, 23 cm Fig. 00, 23 cm Fig. 000, 23 cm Fig. 1, 23 cm Fig. 2, 23 cm Fig. 3,



**SI-7-178-25**

**Scoville**

Bone Curette

25 cm,



**SI-7-179-01**

**Simon**

Bone Curette

25 cm Fig. 1, 25 cm Fig. 2, 25 cm Fig. 3, 25 cm Fig. 4, 25 cm Fig. 5,



**SI-7-180-01**

**Modell USA**

Bone Curette

16 cm Fig. 1, 16 cm Fig. 2, 16 cm Fig. 3, 16 cm Fig. 4,



**SI-7-181-01**

**Modell USA**

Bone Curette

15.5 cm Fig. 1, 15.5 cm Fig. 2, 15.5 cm Fig. 3, 15.5 cm Fig. 4,



**SI-7-182-01**

**Modell USA**

Bone Curette

15.5 cm Fig. 1, 15.5 cm Fig. 2, 15.5 cm Fig. 3, 15.5 cm Fig. 4,



**SI-7-183-01**

**Halle**

Bone Curette

21 cm Fig. 1, 21 cm Fig. 2, 21 cm Fig. 3,



**SI-7-184-01**

**Volkmann**

Bone Curette, double-ended

12.5 cm, 14.5 cm, 17 cm,



**SI-7-185-13**

**Volkmann**

Bone Curette, double-ended

13 cm, 16 cm,



**SI-7-186-21**

Bone Curette, double-ended

21 cm,



**SI-7-187-00**

**Williger**

Bone Curette, double-ended

13.5 cm Fig. 00/0, 13.5 cm Fig. 0/1, 13.5 cm Fig. 1/2,



**SI-7-189-11**

**Hemingway**

Bone Curette, double-ended  
18 cm,



**SI-7-190-00**

**Hemingway**

Bone Curette, double-ended  
18.5 cm,



**SI-7-191-01**

Bone Curette, double-ended  
17.5 cm,

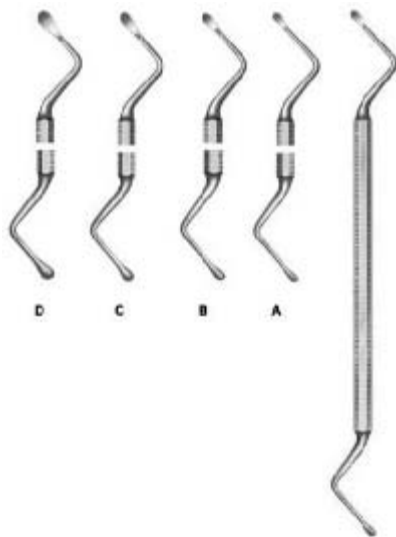

**SI-7-192-11**

**Lucas**

Bone Curette, double-ended  
18 cm,

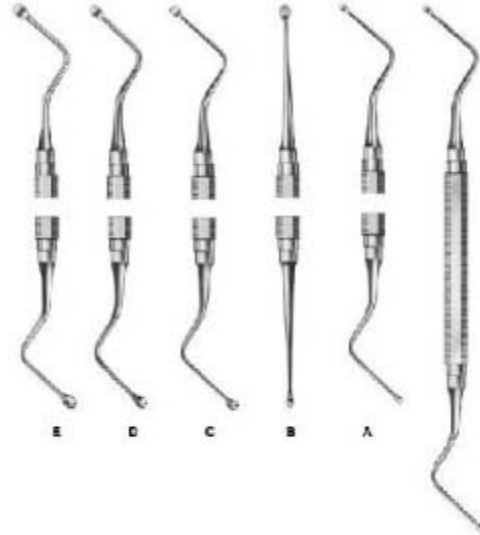

**SI-7-193-00**

**Miller-Colburn**

Bone Curette, double-ended  
17 cm Fig. 0, 17 cm Fig. 1, 17 cm Fig. 2, 17 cm Fig. 3,

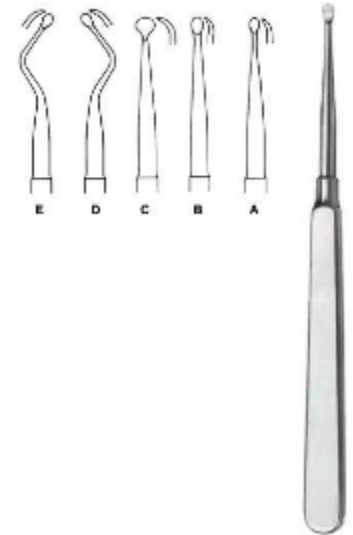

**SI-7-194-01**

**Molt**

Bone Curette  
17 cm Fig. 1, 17 cm Fig. 2, 17 cm Fig. 3, 17 cm Fig. 4,

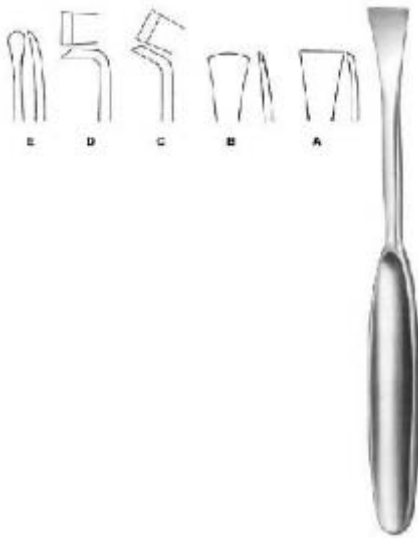

**SI-7-195-01**

**Martin-Langenbeck**

Periosteal Elevator  
19 cm 16mm,



**SI-7-196-18**

**Langenbeck**

Periosteal Elevator  
18.5 cm,



**SI-7-197-19**

**Langenbeck**

Periosteal Elevator  
19.5 cm,



**SI-7-198-05**

Periosteal Elevator  
16 cm 5mm, 16 cm 6mm, 16 cm 7mm,



**SI-7-199-21**

**Sedillot**

Periosteal Elevator  
22 cm 15mm,



**SI-7-200-13**

**Williger**

Periosteal Elevator  
12.5 cm 5mm,



**SI-7-201-04**

**Kahre-Williger**

Periosteal Elevator  
4 mm,5 mm,7 mm,

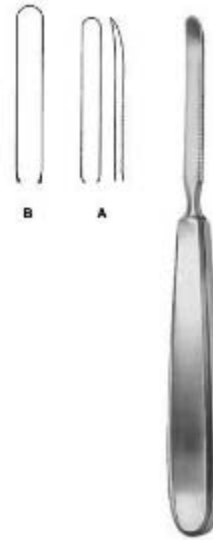

**SI-7-202-06**

Periosteal Elevator

17 cm 6 mm,17 cm 8 mm,



**SI-7-203-17**

**Doyen**

Rib Raspatory  
17.5 cm,

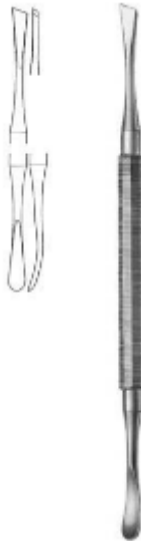

**SI-7-204-19**

**West**

Periosteal Elevator, double-ended  
18.5 cm,



**SI-7-205-17**

**Ohl**

Periosteal Elevator, double-ended  
17.5 cm,



**SI-7-206-01**

**Semb**

Periosteal Elevator  
18.5 cm Fig. 1,21.5 cm Fig. 2,



**SI-7-207-22**

Bone File  
22 cm,



**SI-7-208-17**

**Adson**  
Elevator  
17 cm, 17.5 cm,

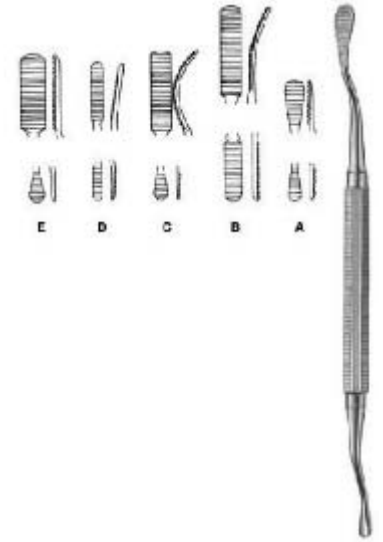

**SI-7-209-01**

**Miller-Colburn**  
Bone File  
18 cm Fig. 1, 18 cm Fig. 2, 18 cm Fig. 3, 18 cm Fig. 4, 18 cm Fig. 5,

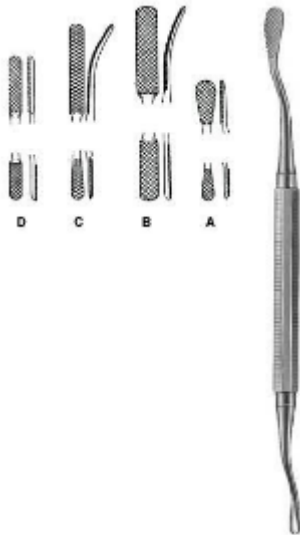

**SI-7-210-01**

**Miller-Colburn**  
Bone File  
18 cm Fig. 1, 18 cm Fig. 2, 18 cm Fig. 3, 18 cm Fig. 4,



**SI-7-211-20**

**Langenbeck**  
Elevator  
19.5 cm 8 mm, 19.5 cm 10 mm,



**SI-7-212-01**

**Martin-Langenbeck**  
Elevator  
17 cm 5 mm, 17 cm 7 mm, 17 cm 8 mm,





**SI-7-213-17**

**Vickers**

Elevator  
17 cm,



**SI-7-214-17**

**Vickers**

Dissector  
17 cm,



**SI-7-215-17**

**Williger**

Elevator  
16 cm 5,5 mm,



**SI-7-216-16**

**Williger**

Elevator  
16 cm 5,5 mm,



**SI-7-217-17**

**Mead**

Mallet  
19 cm,



**SI-7-218-18**

Periosteal Elevator



**SI-7-219-43**

**Hohmann**

Bone Lever  
23.5 cm,



**SI-7-220-19**

**Lempert**

Bone Rongeur  
19 cm,



**SI-7-221-17**

**Luer**

Bone Rongeur  
18.5 cm, 18 cm,



**SI-7-222-18**

**Zaufal-Jansen**

Bone Rongeur  
18 cm,

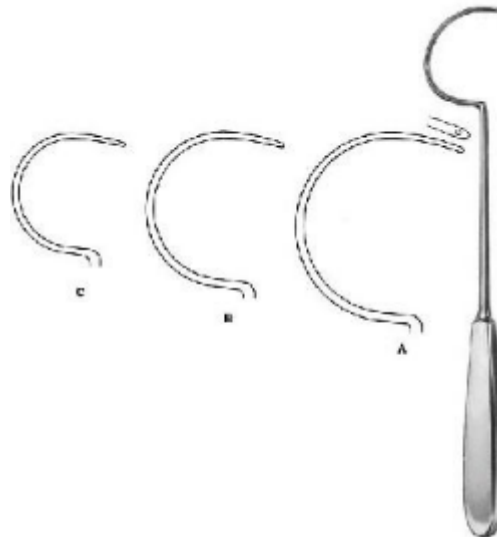

**SI-7-124-01**

**Demel**

Wire Guide  
31 cm Fig. 1, 29 cm Fig. 2, 28 cm Fig. 3,



# Saams Instruments

**Address:** Muhalla Sufi Pura Street # 2 Rang Pura  
Sialkot-51310 Pakistan.

**Tel** : +92-52-4560428

**Fax** : +92-52-4601105

**Direct** : +92-308-4134428

**E-mail** : [info@saamsinst.com](mailto:info@saamsinst.com)

**URL** : [www.saamsinst.com](http://www.saamsinst.com)